

Brooks® GT1000 Series

Industrial Glass Tube Variable Area Flowmeters

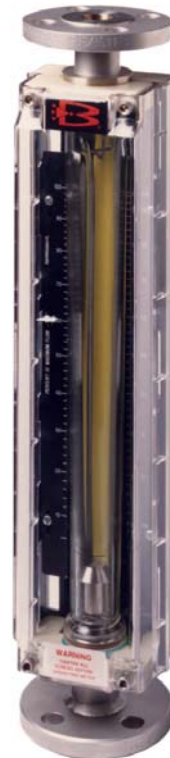

Model GT1020



Model GT1024

Design features

- Brass or 316L SS (1.4404) end fittings
- Flanged or threaded connections
- Horizontal or vertical connections
- Horizontal end fittings 360 degrees rotatable
- Standard accuracy +2% full scale / Class 2.5 acc VDI/VDE
- Epoxy painted cast aluminum frame with outstanding environmental resistance
- Fluid resistant O-ring design allows tube removal without removal from the process piping
- Panel mounting options available

GT1000 Series

Description

The Brooks® GT 1000 combines ruggedness and simplicity in design to provide a versatile glass tube flowmeter suitable for a wide range of applications. The GT 1000 O-ring construction minimizes process downtime by allowing for convenient in-line removal of the glass tube for cleaning and maintenance.

Specifications

Capacities and Pressure Drop Tables

Meter sizes 2 - 6, rib guided tubes, spherical float.
Refer to Table 4.

Meter sizes 7 - 13, rib guided tubes, standard float.
Refer to Table 5.

Meter with alarms.
Refer to Table 6.

Accuracy

Standard Flow Accuracy: $\pm 2\%$ full scale,
Class 2.5 acc VDI/VDE
Optional Flow Accuracy: $\pm 1\%$ of full scale,
Class 1.6 acc VDI/VDE

Repeatability

$\leq 0.5\%$ Full Scale

Pressure Ratings

Refer to Tables 1 & 2 for maximum non-shock pressure.

Scales

Standard: Single or dual detachable aluminum plate
Nominal Lengths: 127 mm, 200 mm, and 250 mm
Graduations: Choice of direct reading units, millimeter or percentage of maximum flow with factor tag

Ambient Temperature Limits

33°F to 125°F (1°C to 52°C)

Operating Fluid Temperature Limits (Meter)

Maximum: 250°F (121°C)

Minimum: 33°F (1°C)

Operating Fluid Temperature Limits (Alarms)

Maximum: 250°F (121°C) - Reed Switch

Maximum: 167°F (75°C) - Inductive Switch

Minimum: 33°F (1°C) - Both

Materials of Construction

Metering Tube

Borosilicate glass

Floats (Figure 1)

Sizes 2 and 6: Sapphire, tantalum, glass, Carboloy®,
316 stainless steel

Size 7: Glass, 316 stainless steel or Monel®

Sizes 8-13: 316 stainless steel

Float Stops

Teflon® for sizes 2, 6, 12 and 13

316 stainless steel springs for sizes 7, 8, 9 and 10

Housing

Cast aluminum alloy with Epoxy paint

End Fittings

316/316L stainless steel (1.4404)
brass

Window

Polycarbonate with UV inhibitor

O-rings

Viton® fluoroelastomers

Buna N

Kalrez® (Stainless Steel Body Only)

EPDM (Stainless Steel Body Only)

Hardware

Stainless Steel

Connections

Brass or Stainless Steel Fittings

NPT or BSPT/RC female connections

Stainless Steel Fittings

150 lbs, 300 lbs RF flanges per ANSI B 16.5

PN 40 DIN 2527

Connection Orientation

Vertical or horizontal on inlet and/or outlet

Meter Dimensions

Refer to Figures 2A and 2B

Certifications

Material certification to DIN 3.1 or 2.2

Calibration certification to NIST and/or NMI

Declaration of Compliance DIN 2.1

Oxygen cleaning

Positive material identification (PMI)

Positive material identification with carbon content (PAMI)

Calibration test level

Weight test level

Declaration of Compliance DIN 3.1

- Pressure test level
- Calibration level
- NACE MR-01-75

**OPTIONAL EQUIPMENT
 (Alarms, Meter Mounting, Valves)**

GT1000 Alarm Contacts Meter Sizes 7 to 13

The Brooks reed switch alarm is a normally open, latching switch used in conjunction with the GT1000 glass tube flow meter for signaling high and/or low flow or a deviation from a flow setting.

A magnet embedded and sealed in the float actuates the alarm switch. The reed switch is mounted adjacent to the flow tube and is easily adjustable over the entire flow range of the instrument.

The sealed reed switch consists of a biasing magnet and hermetically sealed reed switch, which is insulated to prevent damage from mild shock and normal pipe vibration. The contact rating of the switch is very low. An external relay is recommended for secure operation. Plus the external relay can be configured to operate as a normally open or normally closed state which provides totally flexibility of operation.

Alarm Certifications

Data Reed Switch

- Maximum Voltage* 175 Vdc, 124 Vac
 - Maximum Current* 250 mA
 - Maximum Contact Rating* 3 Watts
- *(Maximum Switch Specifications)

Electrical Classification

Non Incendive:

- Maximum Voltage 30 Vdc
- Maximum Current 250 mA
- Maximum Contact Raing 3 Watts



US and Canada E73889

NI Class I, Div 2, Groups A, B, C and D:
 Class II, Groups F and G, T6.
 per UL 1604, Third Edition

Environmental rating: Type 4X

Intrinsically Safe:

Entity parameters:

$$V_{max} = U_i = 30 \text{ Vdc}, I_{max} = 100 \text{ mA}, C_i = 0, L_i = 0$$



US and Canada E73889

IS Class I, II, III, Div 1, Groups A, thru G, T6
 per UL 913: Sixth Edition

Environmental rating: Type 4X

**Inductive Alarms,
 Alarm Contacts Meter Sizes 2 and 6**

Inductive coils for high and/or low flow alarm may be mounted to the instrument to create a highly sensitive, stable and accurate device for signaling high or low flows or deviations from a controlled flow. The inductive alarm can only be used in combination with 316 ss or Carboloy® ball floats. The alarm points may be adjusted over the entire flowmeter range and be set so that any two contacts may be made to operate simultaneously. For hazardous area applications Brooks can supply an approved Namur power supply/ amplifier/relay unit to obtain an intrinsically safe current circuit.

Table 1 Data 10&15-14-N3 Inductive Coils

Power Supply	8 volt nominal (max. 15.5 Vdc)
Current Consumption	Active area clear: > 3 mA
Current Consumption	Active area obscured: < 1 mA
Self Inductance	70 µH
Self Capacitance	90 nF
Electrical Classification	
Intrinsically safe:	
ATEX:	PTB99ATEX2128X Ex II 2 G EEx ia IIC T6
Enclosure Type:	IP67
EMC Directive:	EN 60947-5-2 DIN EN 60947-5-6 (Namur)

Alarm Hysteresis

8mm typical (0.32 in)

Alarm Accessories

Remotely mounted, switch isolator/power supplies are required for inductive alarms and recommended for reed switch alarms. One or two single-pole, double-throw (SPDT) relays are available with either 110 or 220 AC volt units.

GT1000 Series

Panel Mounting of Meter

Hardware is available for front of panel or flush panel mounting. Panel mounting hardware is available for sizes 2 to 10. Panel mounting is not available for meters with flange connections or meters with valves or flow controllers.

Optional Needle Valves / Flow Controllers

For flow rate control, needle valves and/or flow controllers are externally piped to either the inlet or outlet connection of the meter. Valves and flow controllers are available with threaded or flanged connections. Note, solenoid valves should not be used because this type of valve can cause pressure shocks which can damage the glass tube.

Ordering Information and Model Code

Refer to Table 7.

Table 2 Pressure Rating and PED Category - Threaded Connections

Maximum Operating Pressure (PSIG / bar) @ Fluid Temperature Listed		
Meter Size	to 250°F (121°C)	PED Category
2	500 / 34.5	SEP
6	450 / 31	SEP
7	300 / 20.7	SEP
8	250 / 17	SEP
9	200 / 13.8	SEP
10	175 / 12.1	SEP
12	100 / 6.9	SEE NOTE
13	75 / 5.2	SEE NOTE

Note: Size 12 and 13 do not conform to Pressure Equipment Directive 97/23/EC, therefore cannot be sold or used in the EU/EFTA

Table 3 Pressure Rating and PED Category - Flanged Connections

Maximum Operating Pressure (PSIG / bar) @ Fluid Temperature Listed			
Size	ANSI 150# RF to 250°F (121°C)	ANSI 300# RF/DIN PN40 to 250°F (121°C)	PED Category
2	240 / 16.5	500 / 34.5	SEP
6	240 / 16.5	450 / 31	SEP
7	240 / 16.5	300 / 20.7	SEP
8	240 / 16.5	250 / 17	SEP
9	200 / 13.8	200 / 13.8	SEP
10	175 / 12.1	175 / 12.1	SEP
12	100 / 6.9	N/A	SEE NOTE
13	75 / 5.2	N/A	SEE NOTE

Note: Size 12 and 13 do not conform to Pressure Equipment Directive 97/23/EC, therefore cannot be sold or used in the EU/EFTA

Table 4 Capacity and Pressure Drop Meter Sizes 2 & 6

TUBE	SPHERICAL FLOAT	WATER					AIR*			
		Flow Rate		Pressure Drop		V. I. C.	Flow Rate		Pressure Drop	
		cc/min.	l/h	Inches WC	kPa		slpm	m3/nh	Inches WC	kPa
SIZE 2 R-2-127-AAAT	GLASS	0.42	0.025	0.3	0.08	1.0	0.039	0.0021	0.3	0.08
	SAPPHIRE	0.84	0.05	0.4	0.09	1.0	0.06	0.0033	0.4	0.1
	316 SS	1.9	0.11	0.7	0.17	1.0	0.11	0.0066	0.8	0.19
	CARBOLOY	3.9	0.23	1.1	0.27	1.0	0.2	0.011	1.2	0.3
	TANTALUM	4.3	0.26	1.3	0.33	1.0	0.22	0.012	1.4	0.34
SIZE 2 R-2-127-AAT	GLASS	1.4	0.086	0.3	0.08	1.0	0.059	0.0033	0.3	0.08
	SAPPHIRE	1.9	0.11	0.4	0.09	1.0	0.092	0.0051	0.4	0.1
	316 SS	3.0	0.18	0.7	0.18	1.0	0.18	0.01	0.8	0.2
	CARBOLOY	5.9	0.35	1.2	0.29	1.0	0.32	0.017	1.3	0.32
	TANTALUM	6.6	0.39	1.4	0.34	1.0	0.35	0.019	1.5	0.37
SIZE 2 R-2-127-DT	GLASS	4.2	0.25	0.3	0.08	1.0	0.3	0.016	0.3	0.08
	SAPPHIRE	8.0	0.48	0.4	0.1	1.0	0.41	0.023	0.4	0.11
	316 SS	16	0.98	0.9	0.22	1.0	0.68	0.038	1.0	0.24
	CARBOLOY	27	1.6	1.5	0.38	1.0	1.0	0.057	1.7	0.42
	TANTALUM	29	1.7	1.6	0.41	1.0	1.0	0.061	1.8	0.46
SIZE 2 R-2-127-AT	GLASS	13	0.81	0.4	0.09	1.0	0.69	0.039	0.4	0.1
	SAPPHIRE	21	1.3	0.5	0.13	1.0	0.93	0.051	0.6	0.14
	316 SS	38	2.3	1.1	0.27	1.0	1.4	0.08	1.2	0.3
	CARBOLOY	60	3.6	1.9	0.47	1.0	2.0	0.11	2.1	0.52
	TANTALUM	64	3.8	2.1	0.52	1.0	2.2	0.12	2.3	0.58
SIZE 2 R-2-127-BT	GLASS	47	2.8	0.6	0.16	1.0	2.0	0.11	0.7	0.18
	SAPPHIRE	71	4.2	0.8	0.21	1.0	2.7	0.15	0.9	0.23
	316 SS	110	7.1	1.8	0.45	1.0	4.1	0.23	2.0	0.51
	CARBOLOY	170	10	3.0	0.75	1.0	5.9	0.33	3.3	0.83
	TANTALUM	180	11	3.6	0.89	1.0	6.3	0.35	3.9	0.98
SIZE 2 R-2-127-CT	GLASS	69	4.1	0.8	0.21	1.0	3.2	0.18	0.9	0.23
	SAPPHIRE	100	6.4	1.3	0.32	1.0	4.2	0.23	1.4	0.35
	316 SS	180	10	2.5	0.63	1.0	6.3	0.35	2.8	0.7
	CARBOLOY	270	16	4.7	1.17	1.0	9.0	0.50	5.2	1.3
	TANTALUM	290	17	5.1	1.26	1.0	9.5	0.53	5.6	1.4
SIZE 6 R-6-127-AT	GLASS	160	10	1.8	0.45	1.0	7.3	0.4	2.0	0.5
	SAPPHIRE	240	14	2.9	0.72	1.0	9.4	0.52	3.2	0.8
	316 SS	410	24	6.1	1.53	1.0	14	0.78	6.8	1.7
	CARBOLOY	610	36	10.5	2.61	1.0	19	1.1	11.6	2.9
	TANTALUM	650	39	11.2	2.80	1.0	20	1.1	12.4	3.1
SIZE 6 R-6-127-BT	GLASS	450	27	9.4	2.34	1.0	19	1.0	10.4	2.6
	SAPPHIRE	660	40	14.9	3.7	1.0	24	1.3	16.5	4.1
	316 SS	1000	65	30.1	7.5	1.0	35	1.9	33.3	8.3
	CARBOLOY	1500	95	57.8	14.4	1.0	49	2.7	64.2	16
	TANTALUM	1600	100	82.3	20.5	1.0	52	2.9	92.3	23

NOTE: 316 SS AND CARBOLOY FLOAT CAPACITIES LISTED ABOVE CAN BE USED TO SIZE METERS WITH OPTIONAL INDUCTANCE-TYPE ALARMS

(*) Air flow rates in standard units are at 70°F and 14.7 PSIA, air flow rates in normal units are at 1.013 bar & 20°C

GT1000 Series

Table 5 Capacities 200mm, 250mm Scale, Rib Guided Tubes, Standard Float

TUBE	FLOAT	Water					Air****					
		Flow Rate		Pressure Drop		V. I. C.**	Flow Rate		Pressure Drop		REQ. psi(*)	REQ. bar(*)
		GPM	l/h	INCHES W.C.	kPa		SCFM	m3n/h	INCHES W.C.	kPa		
Size 7 R-7M-25-1FT	GLASS	0.16	36	2.0	0.5	1.0	0.88	1.4	2.0	0.5	0	0
	316 SS	0.38	86	3.0	0.75	1.0	1.6	2.6	4.0	1	0	0
	MONEL	0.37	84	4.0	1	1.0	1.6	2.6	4.0	1	0	0
Size 8 8-8M-25-4FT	8-RV-2	0.52	110	2.0	0.5	1.0	2.1	3.4	2.0	0.5	0	0
	8-RV-3	0.77	170	3.0	0.75	2.0	3.1	5.0	3.0	0.75	0	0
	8-RV-8	1.0	240	5.0	1.3	3.7	4.4	7.0	5.0	1.3	0	0
	8-RS-8	1.3	310	6.0	1.5	1.8	5.8	9.2	6.0	1.5	0	0
	8-RV-14	1.4	320	8.0	2	5.4	5.8	9.2	8.0	2	0	0
	8-RS-14	1.8	410	10	2.5	1.9	7.5	11	11	2.8	0	0
	8-RV-31	2.0	460	16	4	7.0	8.3	13	17	4.3	30	2
	8-RS-31	2.5	580	20	5	3.1	10	16	22	5.5	30	2
	8-LJ-48 ****	4.8	1100	52	13	1.0	20	33	57	14	30	2
Size 9 R-9M-25-3FT	9-RV-33	2.5	570	6.0	1.5	11	10	16	7.0	1.8	0	0
	9-RS-33	3.2	730	4.0	1	2.4	13	21	8.0	2.0	0	0
	9-RV-87	3.9	890	14	3.5	17	16	26	16	4.0	30	2
	9-RS-87	5.1	1100	18	4.5	3.5	21	35	19	4.8	30	2
	9-LJ-160 ****	9.6	2100	43	11	1.0	44	72	55	14	30	2
Size 10 R-10M-25-3FT	10-RV-64	6.2	1400	12	3	15	25	40	14	3.5	0	0
	10-RS-64	7.8	1700	16	4	3.7	32	50	18	4.5	0	0
	10-RV-138	8.8	2000	24	6	23	36	60	28	7	30	2
	10-RS-138	10	2400	30	7.5	5.5	46	76	36	9	30	2
	10-LJ-238 ****	20	4600	104	26	1.0	92	150	16	4	30	2
Size 12 R-12M-20-5FT	12-RV-119	13	2900	4.0	1	30	56	88	4.0	1	0	0
	12-RV-221	17	3900	10	2.5	32	70	110	12	3	0	0
	12-RV-343	20	4700	16	4	24	86	140	20	5	30	2
	12-RS-343	26	6100	20	5	10	110	180	24	6	30	2
	12-HF-455 ****	42	9700	30	7.5	10	170	280	32	8	30	2
Size 13 R-13M-20-3FT	12-LJ-740 ****	68	15000	112	28	1.0	300	490	120	30	30	2
	13-RV-510	31	7200	26	6.5	40	130	200	28	7	0	0
	13-RV-760A	37	8500	36	9	45	170	270	42	11	30	2
	13-RS-510	42	9600	36	9	20	170	270	40	10	0	0
	13-RS-760A	50	11000	56	14	25	210	340	64	16	30	2
	13-HF-758 ****	62	14000	40	10	12	270	440	44	11	30	2
	13-LJ-1394 ****	98	22000	200	50	1.0						

(*) Minimum operating downstream pressure for gas service in PSIG.

(**) Viscosity immunity ceiling listed is for stainless steel float, fluid specific gravity 1.0

(***) Consult factory for viscosity sizing.

(****) Extended range - nonviscosity compensating floats.

(*****) Air flow rates in standard units are at 70°F and 14.7 PSIG, air flow rates in normal units are at 1.013 bar & 20°C

Table 6 Capacities 127mm, 200mm, 250mm Scale, Rib Guided Tubes, Alarm Floats

TUBE	FLOAT	Water					Air****					
		Flow Rate		Pressure Drop		V. I. C.**	Flow Rate		Pressure Drop		REQ. psi(*)	REQ. bar(*)
		GPM	l/h	INCHES W.C.	kPa		SCFM	m3n/h	INCHES W.C.	kPa		
Size 2		Refer to Table 3***										
Size 6		Refer to Table 3***										
Size 7 R-7M-25-1FT	7-XV-11A	0.48	100	8.0	2.0	3.0	1.9	3.0	10	2.5	0	0
	7-XS-15	0.61	130	10	2.5	1.5	2.7	4.5	12	3.0	30	2
	7-XS-23	0.81	180	16	4.0	1.0	3.4	5.6	16	4.0	30	2
Size 8 R-8M-25-4FT	8-XV-14	1.4	320	8.0	2.0	5.4	6	9.2	8.0	2.0	0	0
	8-XS-14	1.8	410	10	2.5	1.9	8	11	11	2.8	0	0
	8-XV-31	2	460	16	4.0	7.0	8	13	17	4.3	30	2
Size 9 R-9M-25-3FT	8-XS-31	2.5	580	20	5.0	3.1	10	17	22	5.5	30	2
	9-XV-40	2.8	630	6.0	1.5	11	10	18	7.0	1.8	0	0
	9-XS-40	3.5	810	4.0	1.0	2.4	13	22	8.0	2.0	0	0
Size 10 R-10M-25-3FT	9-XV-87	3.9	890	14	3.5	17	16	26	16	4.0	30	2
	9-XS-87	5.1	1100	18	4.5	3.5	21	35	19	4.8	30	2
	10-XV-64	6.2	1400	11	2.8	15	25	40	13	3.3	0	0
	10-XS-64	7.8	1700	15	3.8	3.7	32	50	17	4.3	0	0
	10-XV-138	8.8	2000	23	5.8	23	36	59	28	7.0	30	2
Size 12 R-12M-20-5FT	10-XS-138	10	2400	30	7.5	5.5	45	75	36	9.0	30	2
	12-XV-221	17	3900	10	2.5	29	70	110	12	3.0	0	0
	12-XV-343	20	4700	16	4.0	36	94	150	18	4.5	30	2
	12-XS-343	26	6000	20	5.0	4.5	110	190	22	5.5	30	2
	12-XHF-455	42	9600	30	7.5	1.0	170	290	32	8.0	30	2
Size 13 R-13M-20-3FT	13-XV-510	31	7200	26	6.5	42	130	200	28	7.0	0	0
	13-XV-760A	37	8500	36	9.0	52	150	250	40	10	30	2
	13-XS-510	42	9600	36	9.0	7.6	170	270	40	10	0	0
	13-XS-760A	50	11000	56	14	9.3	210	350	60	15	30	2
	13-XHF-758	62.00	14000	40	10	1.0	270	450	44	11	30	2

(*) Minimum operating downstream pressure for gas service (psig)

(**) Viscosity immunity ceiling listed is for stainless steel float, fluid specific gravity 1.0

Note 1: All size 8-13 floats listed are 316 SS with integral magnet for use with reed switch alarm.

Alarm option for sizes 2 and 6 requires metallic float (SS or carbonyl) for use with inductive type alarm.

(***) Air flow rates in standard units are at 70°F and 14.7 PSIG, air flow rates in normal units are at 1.013 bar & 20°C

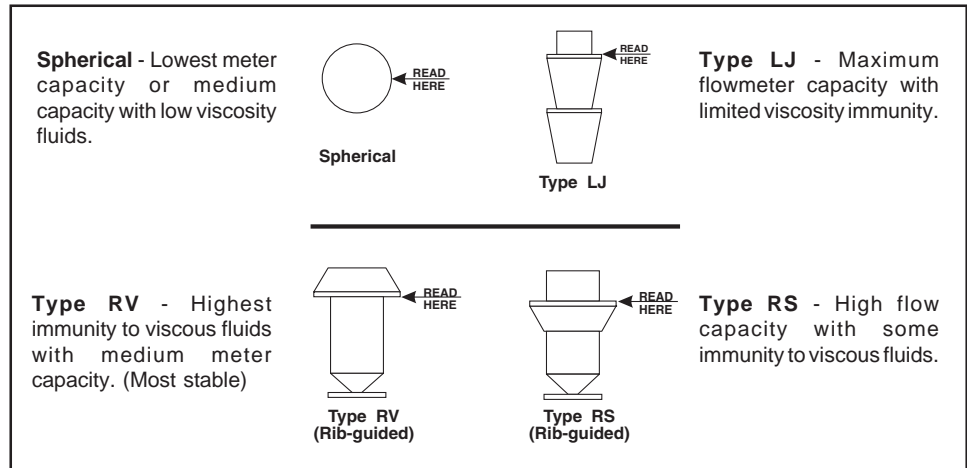

Figure 1 GT 1000 Floats (Descriptions refer to floats used in the same size tube)

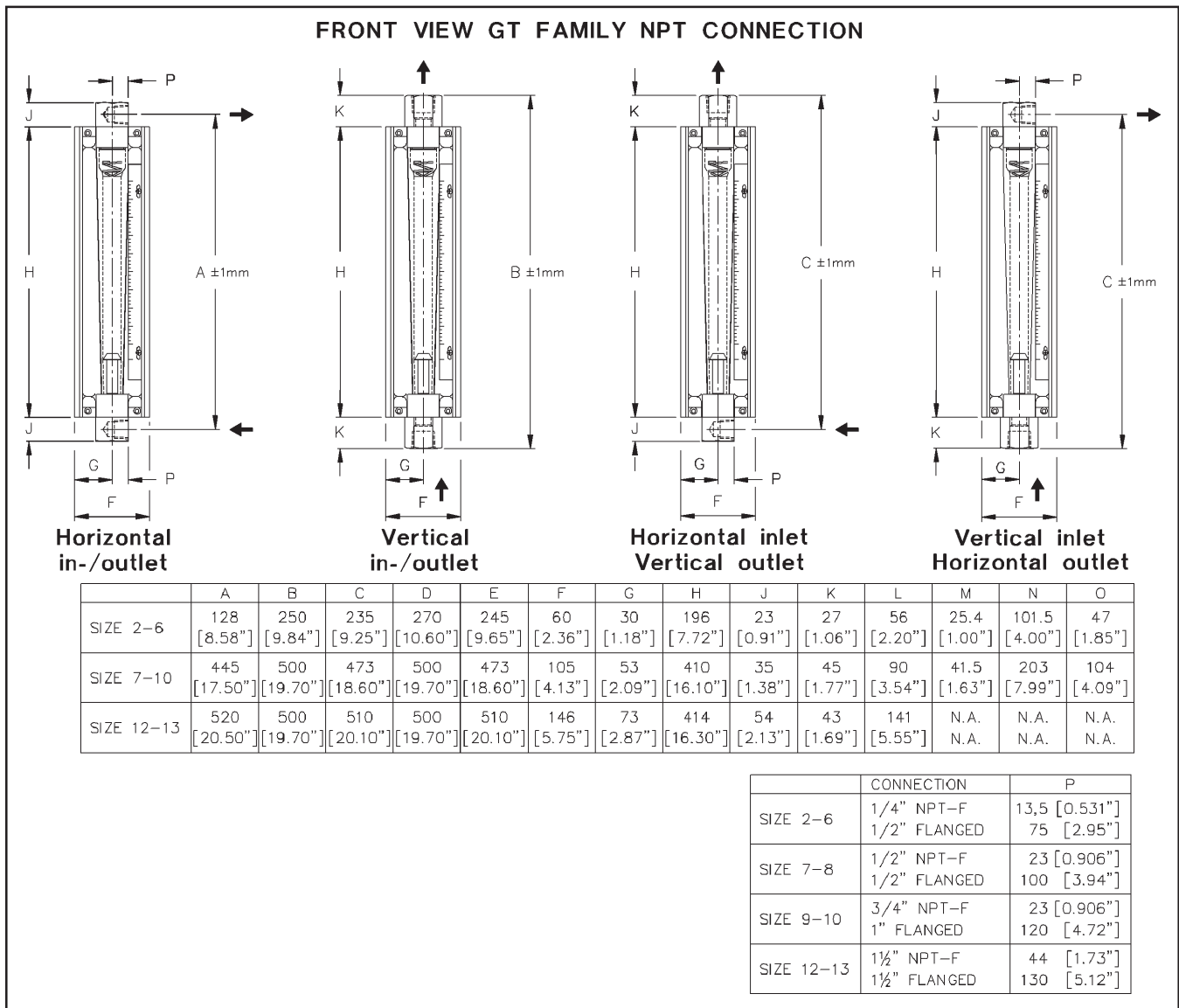

Figure 2A GT1000 Family of Meters

GT1000 Series

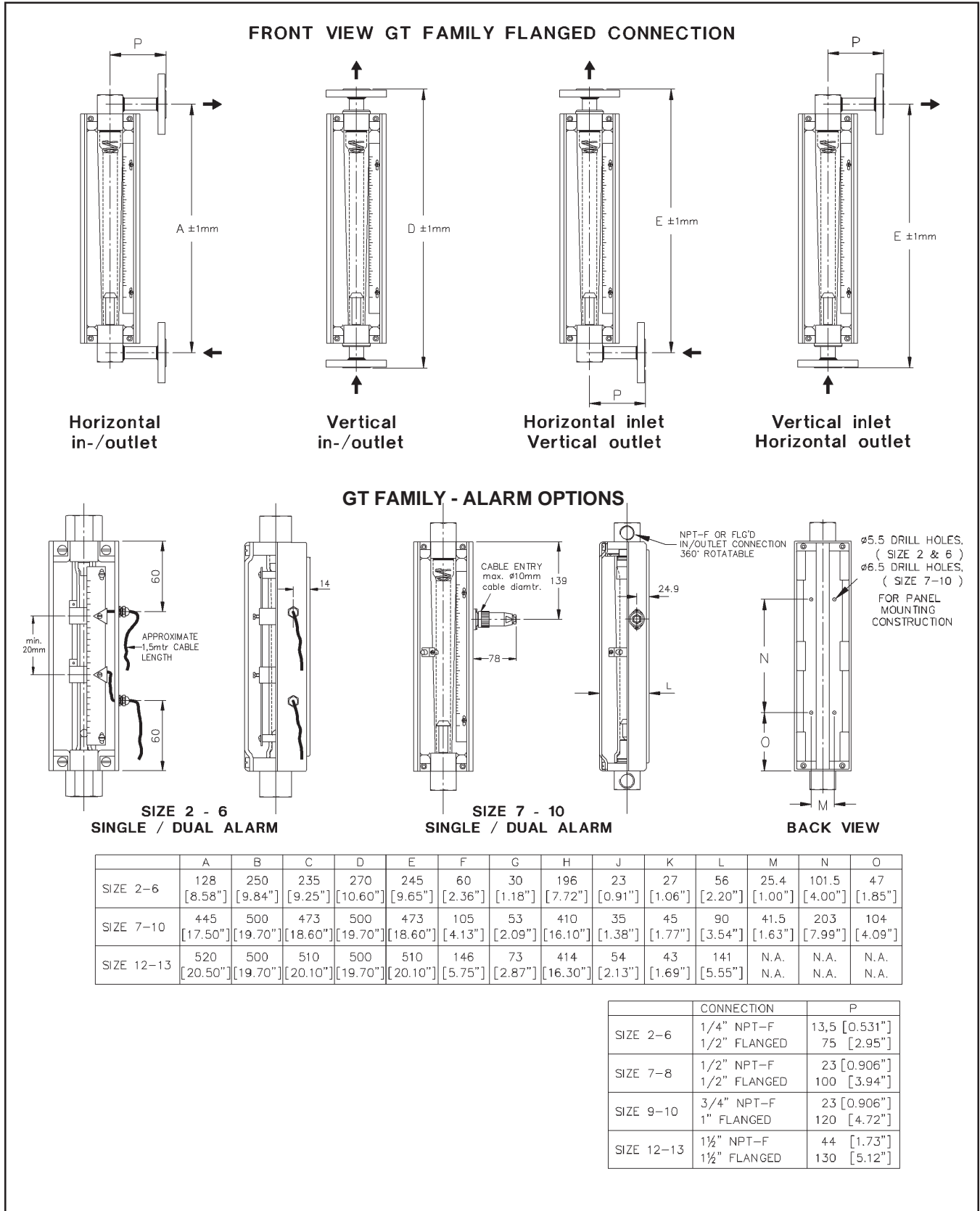

Figure 2B GT 1000 Family of Meters

Table 7 Model GT 1000 Ordering Information and Model Code

Model: GT 1000 INDUSTRIAL GLASS TUBE VA METER							
BASE MODEL NUMBER		CONNECTION ORIENTATION					
1020N		HORIZONTAL INLET AND OUTLET					
1024N		VERTICAL INLET AND OUTLET					
1026N		HORIZONTAL INLET AND VERTICAL OUTLET					
1027N		VERTICAL INLET AND HORIZONTAL OUTLET					
		SIZE	TUBE				
A		SIZE 2	R-2-127-AAAT				
B		SIZE 2	R-2-127-AAT				
C		SIZE 2	R-2-127-DT				
D		SIZE 2	R-2-127-AT				
E		SIZE 2	R-2-127-BT				
F		SIZE 2	R-2-127-CT				
G		SIZE 6	R-6-127-AT				
H		SIZE 6	R-6-127-BT				
J		SIZE 7	R-7M-25-1FT				
K		SIZE 8	R-8M-25-4FT				
L		SIZE 9	R-9M-25-3FT				
M		SIZE 10	R-10M-25-3FT				
N		SIZE 12	R-12M-20-5FT (NOT AVAILABLE IN EU)				
P		SIZE 13	R-13M-20-3FT (NOT AVAILABLE IN EU)				
ALARM							
		SWITCH	RELAY				
0		NONE	NONE				
1		1 SWITCH/SENSOR	NO RELAY				
2		2 SWITCHES/SENSORS	NO RELAY				
3		1 SWITCH/SENSOR	220 VAC IS RELAY (SPDT)				
4		2 SWITCHES/SENSORS	220 VAC IS RELAY (SPDT)				
5		1 SWITCH/SENSOR	110 VAC IS RELAY (SPDT)				
6		2 SWITCHES/SENSORS	110 VAC IS RELAY (SPDT)				
FLOAT							
STANDARD FLOATS SIZE 2, 6 & 7		SIZE 2	SIZE 6	SIZE 7			
1		GLASS	GLASS	GLASS			
2		SAPPHIRE	SAPPHIRE				
3	ALARM FLOAT SIZE 2 & 6	316 SS	316 SS	316 SS			
4	ALARM FLOAT SIZE 2 & 6	CARBOLOY	CARBOLOY				
5		TANTALUM	TANTALUM				
6				MONEL			
STANDARD FLOATS SIZE 8 - 13		SIZE 8	SIZE 9	SIZE 10	SIZE 12	SIZE 13	
A		8-RV-2	9-RV-33	10-RV-64	12-RV-119	13-RV-510	
B		8-RV-3	9-RS-33	10-RS-64	12-RV-221	13-RS-510	
C		8-RV-8	9-RV-87	10-RV-138	12-RV-343	13-RV-760A	
D		8-RS-8	9-RS-87	10-RS-138	12-RS-343	13-RS-760A	
E		8-RV-14	9-LJ-160	10-LJ-238	12-HF-455	13-HF-758	
F		8-RS-14			12-LJ-740	13-LJ-1394	
G		8-RV-31					
H		8-RS-31					
J		8-LJ-48					
ALARM FLOATS SIZE 7 - 13		SIZE 7	SIZE 8	SIZE 9	SIZE 10	SIZE 12	SIZE 13
N		7-XV-11A	8-XV-14	9-XV-40	10-XV-64	12-XV-221	13-XV-510
P		7-XS-15	8-XS-14	9-XS-40	10-XS-64	12-XV-343	13-XS-510
Q		7-XS-23	8-XV-31	9-XV-87	10-XV-138	12-XS-343	13-XV-760A
R			8-XS-31	9-XS-87	10-XS-138	12-XHF-455	13-XS-760A
S							13-XHF-758
END FITTING MATERIAL AND CERTIFICATION							
1		BRASS					
2		316 STAINLESS STEEL					
3		316 STAINLESS STEEL WITH MATERIAL CERTIFICATE 2.2					
4		316 STAINLESS STEEL WITH MATERIAL CERTIFICATE 3.1					

GT1000 Series

Table 7 Model GT 1000 Ordering Information and Model Code (continued)

		O-RING MATERIAL
A		VITON
B		BUNA
C		KALREZ
D		EPDM
		CONNECTION TYPE
A		NPT-F THREADED
B		Rc (BSP) THREADED
C		ANSI 150# RF FLANGE
D		ANSI 300# RF FLANGE
E		DIN PN40 RF FLANGE
		CONNECTION SIZE
1		1/4"
2		1/2"
3		3/4"
4		1"
5		1 1/2"
		RIGHT SIDE SCALE INSCRIPTION (WHEN FACING METER)
9		NO SCALE REQUIRED AT THIS LOCATION
A		NO INSCRIPTION (BLANK SCALE)
B		MM SCALE
C		PERCENT SCALE - FLUID GAS
D		PERCENT SCALE - FLUID LIQUID
E		DIRECT READING SCALE - FLUID LIQUID
F		DIRECT READING SCALE - FLUID GAS
G		DIRECT READING SCALE - FLUID HIGH VISCOSITY
		LEFT SIDE SCALE INSCRIPTION (WHEN FACING METER)
9		NO SCALE REQUIRED AT THIS LOCATION
A		NO INSCRIPTION (BLANK SCALE)
B		MM SCALE
C		PERCENT SCALE - FLUID GAS
D		PERCENT SCALE - FLUID LIQUID
E		DIRECT READING SCALE - FLUID LIQUID
F		DIRECT READING SCALE - FLUID GAS
G		DIRECT READING SCALE - FLUID HIGH VISCOSITY
		METER ACCURACY
C		2% FULL SCALE
D		2% FULL SCALE AND CERTIFICATION TO NIST
E		1% FULL SCALE
F		1% FULL SCALE AND CERTIFICATION TO NIST
J		2.5 VDI
K		2.5 VDI AND CERTIFICATION TO NMI
L		1.6 VDI
M		1.6 VDI AND CERTIFICATION TO NMI
		NEEDLE VALVE/ FLOW CONTROLLER
0		NONE
A		VALVE ON INLET
B		VALVE ON OUTLET
C		FLOW CONTROLLER ON INLET
D		FLOW CONTROLLER ON OUTLET
		PANEL MOUNTING
0		NONE
1		FRONT PANEL MOUNTING
2		BACK PANEL MOUNTING
		PROCESSES WITH CERTIFICATES
0		NONE
A		DECLARATION OF COMPLIANCE 2.1 OXYGEN SERVICE
B		DECLARATION OF COMPLIANCE 2.1 POSITIVE MATERIAL IDENTIFICATION (PMI)
C		DECLARATION OF COMPLIANCE 2.1 POSITIVE ALLOY MATERIAL IDENTIFICATION (PAMI)
D		DECLARATION OF COMPLIANCE 2.1 OXYGEN SERVICE & PMI
E		DECLARATION OF COMPLIANCE 2.1 OXYGEN SERVICE & PAMI

Table 7 Model GT 1000 Ordering Information and Model Code (continued)

ADDITIONAL CERTIFICATE REQUIREMENTS	
0	NONE
A	DECLARATION OF COMPLIANCE 2.1
B	DECLARATION OF COMPLIANCE 2.1 CALIBRATION TEST
C	DECLARATION OF COMPLIANCE 2.1 PRESSURE TEST
D	DECLARATION OF COMPLIANCE 2.1 WEIGHT TEST
E	PRESSURE INSPECTION TEST CERTIFICATE 3.1
F	CALIBRATION INSPECTION TEST CERTIFICATE 3.1
G	DECLARATION OF COMPLIANCE 2.1 NACE MR-01-75
H	HAZARDOUS LOCATION CERTIFICATE
9	TWO OR MORE CERTIFICATES FROM ABOVE LIST
OEM	
1	STANDARD
2	NO BROOKS IDENTIFICATION

Example: GTAK0A2AA3B9C01011

NOTE: INDUCTIVE ALARMS SIZE 2 AND 6 REQUIRE RELAY FOR PROPER OPERATION

APPROXIMATE WEIGHTS (ALL UNITS IN POUNDS / KILOGRAMS)

METER SIZE	NPT CONNECTIONS	FLANGED CONNECTIONS
	SHIPPING WEIGHT	SHIPPING WEIGHT
2 TO 6	7 / 3.2	10 / 4.5
7 AND 8	12 / 5.5	13 / 5.9
9	18 / 6.2	20 / 9
10	25 / 11.4	29 / 13.2
12	39 / 17.7	49 / 22.3
13	40 / 18.2	52 / 23.6

GT1000 Series

BROOKS SERVICE AND SUPPORT

Brooks is committed to assuring all of our customers receive the ideal flow solution for their application, along with outstanding service and support to back it up. We operate first class repair facilities located around the world to provide rapid response and support. Each location utilizes primary standard calibration equipment to ensure accuracy and reliability for repairs and recalibration. The primary standard calibration equipment to calibrate our flow products is certified by our local Weights and Measures Authorities and traceable to the relevant International Standards.

Visit www.BrooksInstrument.com to locate the service location nearest to you.

START-UP SERVICE AND IN-SITU CALIBRATION



Brooks Instrument can provide start-up service prior to operation when required. For some process applications, where ISO-9001 Quality Certification is important, it is mandatory to verify and/or (re)calibrate the products periodically. In many cases this service can be provided under in-situ conditions, and the results will be traceable to the relevant international quality standards.

CUSTOMER SEMINARS AND TRAINING

Brooks Instrument can provide customer seminars and dedicated training to engineers, end users and maintenance persons. Please contact your nearest sales representative for more details.

HELP DESK

In case you need technical assistance:

Americas	 1 888 554 FLOW
Europe	 +31 (0) 318 549 290
Asia	 +81 (0) 3 5633 7100

Due to Brooks Instrument's commitment to continuous improvement of our products, all specifications are subject to change without notice.

TRADEMARKS

Brooks	Brooks Instrument, LLC
Carboloy	General Electric Co.
Kalrez	DuPont Dow Elastomers
Monel	Inco Alloys International, Inc.
Teflon	E.I. DuPont de Nemours & Co.
Viton	DuPont Performance Elastomers



Brooks Instrument
407 West Vine Street
P.O. Box 903
Hatfield, PA 19440-0903 USA
T (215) 362 3700
F (215) 362 3745
E-Mail BrooksAm@BrooksInstrument.com
www.BrooksInstrument.com

Brooks Instrument
Neonstraat 3
6718 WX Ede, Netherlands
T +31 (0) 318 549 300
F +31 (0) 318 549 309
E-Mail BrooksEu@BrooksInstrument.com

Brooks Instrument
1-4-4 Kitasuna Koto-Ku
Tokyo, 136-0073 Japan
T +81 (0) 3 5633 7100
F +81 (0) 3 5633 7101
E-Mail BrooksAs@BrooksInstrument.com

BROOKS[®]
INSTRUMENT