

Installation and Operation Manual

X-TMF-5860E-MFM-eng
Part Number: 541B106AAG
November, 2008

Model 5860E Mass Flow Meter



Essential Instructions

Read this page before proceeding!

Brooks Instrument designs, manufactures and tests its products to meet many national and international standards. Because these instruments are sophisticated technical products, you must properly install, use and maintain them to ensure they continue to operate within their normal specifications. The following instructions must be adhered to and integrated into your safety program when installing, using and maintaining Brooks Products.

- Read all instructions prior to installing, operating and servicing the product. If this instruction manual is not the correct manual, please see back cover for local sales office contact information. Save this instruction manual for future reference.
- If you do not understand any of the instructions, contact your Brooks Instrument representative for clarification.
- Follow all warnings, cautions and instructions marked on and supplied with the product.
- Inform and educate your personnel in the proper installation, operation and maintenance of the product.
- Install your equipment as specified in the installation instructions of the appropriate instruction manual and per applicable local and national codes. Connect all products to the proper electrical and pressure sources.
- To ensure proper performance, use qualified personnel to install, operate, update, program and maintain the product.
- When replacement parts are required, ensure that qualified people use replacement parts specified by Brooks Instrument. Unauthorized parts and procedures can affect the product's performance and place the safe operation of your process at risk. Look-alike substitutions may result in fire, electrical hazards or improper operation.
- Ensure that all equipment doors are closed and protective covers are in place, except when maintenance is being performed by qualified persons, to prevent electrical shock and personal injury.

Pressure Equipment Directive (PED)

All pressure equipment with an internal pressure greater than 0.5 bar (g) and a size larger than 25mm or 1" (inch) falls under the Pressure Equipment Directive (PED). The Directive is applicable within the European Economic Area (EU plus Norway, Iceland and Liechtenstein). Pressure equipment can be traded freely within this area once the PED has been complied with.

- Section 1 of this manual contains important safety and operating instructions related to the PED directive.
- Meters described in this manual are in compliance with EN directive 97/23/EC module H *Conformity Assessment*.
- All Brooks Instrument Flowmeters fall under fluid group 1.
- Meters larger than 25mm or 1" (inch) are in compliance with category I, II, III of PED.
- Meters of 25mm or 1" (inch) or smaller are Sound Engineering Practice (SEP).

ESD (Electrostatic Discharge)

CAUTION

This instrument contains electronic components that are susceptible to damage by static electricity. Proper handling procedures must be observed during the removal, installation or other handling of circuit boards or devices.

Handling Procedure:

1. Power to unit must be removed.
2. Personnel must be grounded, via a wrist strap or other safe, suitable means before any printed circuit card or other internal device is installed, removed or adjusted.
3. Printed circuit cards must be transported in a conductive container. Boards must not be removed from protective enclosure until immediately before installation. Removed boards must immediately be placed in protective container for transport, storage or return to factory.

Comments

This instrument is not unique in its content of ESD (electrostatic discharge) sensitive components. Most modern electronic designs contain components that utilize metal oxide technology (NMOS, SMOS, etc.). Experience has proven that even small amounts of static electricity can damage or destroy these devices. Damaged components, even though they appear to function properly, exhibit early failure.

Installation and Operation Manual

X-TMF-5860E-MFM-eng
Part Number: 541B106AAG
November, 2008

Brooks® Model 5860E

Dear Customer,

We appreciate this opportunity to service your flow measurement and control requirements with a Brooks Instrument device. Every day, flow customers all over the world turn to Brooks Instrument for solutions to their gas and liquid low-flow applications. Brooks provides an array of flow measurement and control products for various industries from biopharmaceuticals, oil and gas, fuel cell research and chemicals, to medical devices, analytical instrumentation, semiconductor manufacturing, and more.

The Brooks product you have just received is of the highest quality available, offering superior performance, reliability and value to the user. It is designed with the ever changing process conditions, accuracy requirements and hostile process environments in mind to provide you with a lifetime of dependable service.

We recommend that you read this manual in its entirety. Should you require any additional information concerning Brooks products and services, please contact your local Brooks Sales and Service Office listed on the back cover of this manual or visit www.BrooksInstrument.com

Yours sincerely,
Brooks Instrument

*THIS PAGE WAS
INTENTIONALLY
LEFT BLANK*

**Section 1
Introduction**

<u>Paragraph Number</u>		<u>Page Number</u>
1-1	Purpose	1-1
1-2	Description	1-1
1-3	Specifications	1-2

**Section 2
Installation**

2-1	Receipt of Equipment	2-1
2-2	Recommended Storage Practice	2-1
2-3	Return Shipment	2-2
2-4	Gas Connections	2-2
2-5	Installation	2-2
2-6	In-Line Filter	2-4
2-7	Electrical Interfacing	2-5

**Section 3
Operation**

3-1	Theory of Operation	3-1
3-2	Operating Procedure	3-2
3-3	Zero Adjustment	3-2
3-4	Calibration Procedure	3-3
3-5	Response (Flow Output Signal)	3-6

**Section 4
Maintenance**

4-1	General	4-1
4-2	Troubleshooting	4-1
4-3	Sensor Tube	4-4
4-4	Disassembly and Assembly	4-4
4-5	Use of the Conversion Tables	4-6
4-6	Restrictor Sizing	4-9

**Section 5
Parts List**

5-1	General	5-1
-----	---------------	-----

**Section A
CE Certification**

	CE Certification of Mass Flow Equipment	A-1
--	---	-----

Brooks® Model 5860E

Figures

<u>Figure</u> <u>Number</u>		<u>Page</u> <u>Number</u>
1-1	Typical Response to Flow Step Changes	1-2
2-1	Model 5860E Dimensions	2-3
2-2	"D" Type Connector Pin Arrangement	2-3
3-1	Flow Sensor Operational Diagram	3-2
3-2	Model 5860E Calibration Connections	3-4
3-3	Adjustment Potentiometer Location	3-4
3-4	Fast Response Adjustment	3-4
5-1	Model 5860E Parts Drawing	5-2

Tables

<u>Table</u> <u>Number</u>		<u>Page</u> <u>Number</u>
2-1	Recommended Filter Size	2-4
4-1	Bench Troubleshooting	4-2
4-2	Sensor Troubleshooting	4-2
4-3	Conversion Factors (Nitrogen Base)	4-7
4-4	Model 5860E Standard Restrictors	4-11
5-1	Model 5860E Replacement Parts List	5-3
5-2	Tool and Spare Part Kits for 5860E	5-3

1-1 Purpose

The Brooks® Model 5860E Flow Meter is a mass flow measurement device designed for accurately measuring flows of gases. This instruction manual is intended to provide the user with all the information necessary to install, operate and maintain the Brooks 5860E Mass Flow Meter. This manual is organized into five sections:

- Section 1 - Introduction
- Section 2 - Installation
- Section 3 - Operation
- Section 4 - Maintenance
- Section 5 - Parts List

It is recommended that this manual be read in its entirety before attempting to operate or repair the Model 5860E.

1-2 Description

The Brooks Model 5860E Mass Flow Meter is used widely in the Semiconductor Industry as well as many others, where manual, electronic or computer controlled gas handling occurs. The Model 5860E consists of two basic units: a flow sensor, and an integral electronic signal converter. This combination produces a stable gas flow indication, which eliminates the need to continuously monitor and compensate for changing gas pressures and temperatures. Standard features include:

Fast Response rapidly indicates changes in actual mass flow rate. Refer to Figure 1-1.

Removable Cleanable Sensor permits the user to clean or replace the sensor. Refer to Section 4-4.

Output Limiting prevents possible damage to delicate data acquisition devices by limiting the output to +6.8 Vdc and -.7 Vdc.

Brooks® Model 5860E

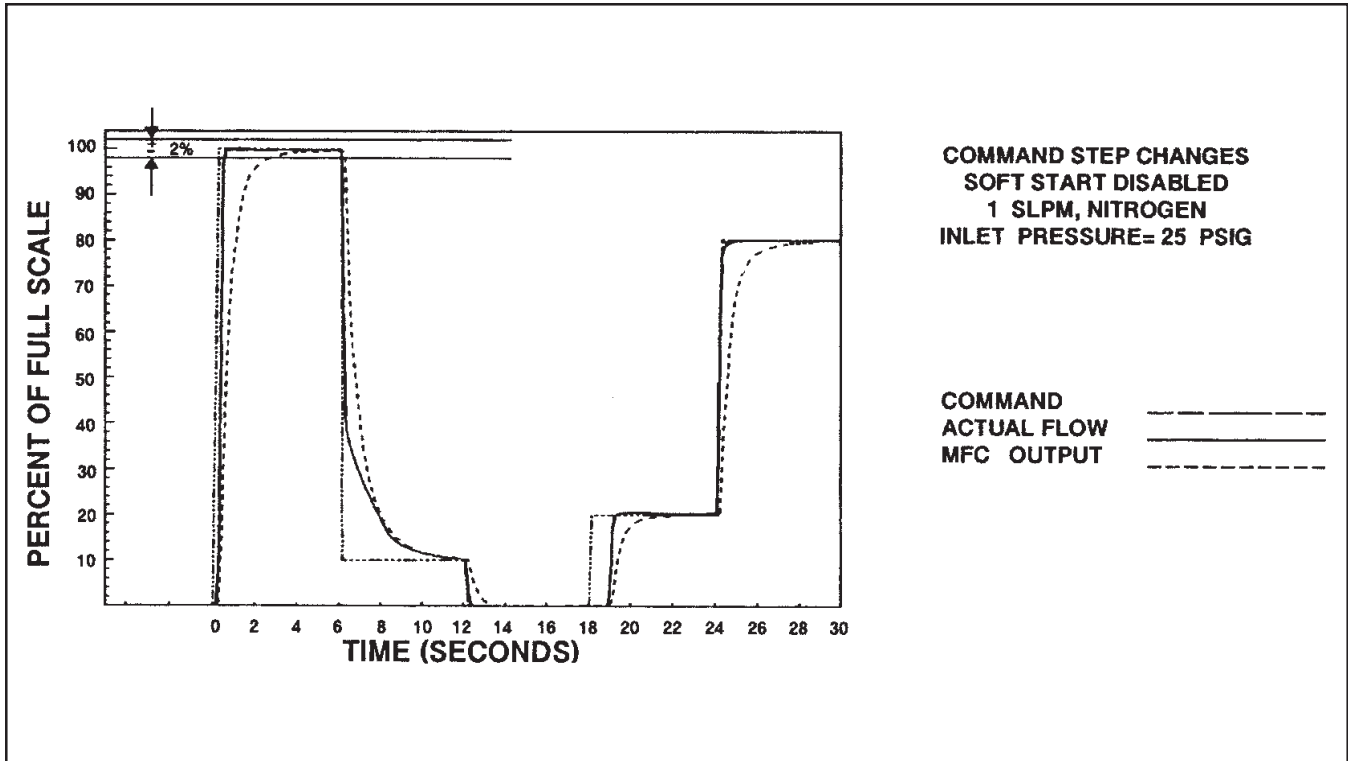

Figure 1-1 Typical Response to Flow Step Changes

1-3 Specifications

⚠ WARNING

Do not operate this instrument in excess of the specifications listed below. Failure to heed this warning can result in serious personal injury and/or damage to the equipment.

Flow Ranges

Any full scale flowrate from 3 sccm to 30 slpm, N₂

*Standard temperature and pressure in accordance with SEMI (Semiconductor Equipment and Materials Institute) standard: 0° C and 101.3 kPa (760 Torr).

Ratings

Maximum Operating pressure: 4500 psi (31.03 MPa)

Ambient/Operating Temperature: 40°F to 150°F (5°C to 65°C)

Non-Operating: -13°F to +212°F (-25°C to 100°C)

Performance

Accuracy: ±1% full scale including linearity at calibration conditions.

±1.5% full scale including linearity for flow ranges greater than 20 slpm.

Repeatability

0.25% of rate

Response Time

Less than 3 seconds response to within 2% of full scale final value for a 0 to 100% command step.

Control / Usable Range

50 to 1

Sensitivity to Mounting Attitude

±0.5% F.S. maximum deviation from specified accuracy after re-zeroing under 200 psig.

Temperature Sensitivity

Zero: Less than ±0.075% F.S. per degree C

Span: Less than ±1.0% F.S. shift from original calibration over 10-50° C range

Pressure Sensitivity

0.03% per PSI up to 200 PSIG

Power Supply Sensitivity

±0.09% full scale per % power supply voltage variation

Output Signal

0-5 Vdc into 2000 ohms (or greater) load.

Maximum ripple 3 mV.

Leak Integrity

1 x 10⁻⁹ Atmosphere scc/sec. Helium

Power Requirements

+15 Vdc (±5%) at 35 mA dc

-15 Vdc (±5%) at 35 mA dc

1.05 watts power consumption

Materials of Construction

Fittings and Transducer Assembly - Wetted parts 316 stainless steel

O-rings and gaskets - Standard: Viton® fluoroelastomers and Buna-N;

Optional: Kalrez®

Electrical Connection

D-connector, 15 pin type (DA-15P)

*THIS PAGE WAS
INTENTIONALLY
LEFT BLANK*

2-1 Receipt of Equipment

When the equipment is received, the outside packing case should be checked for damage incurred during shipment. If the packing case is damaged, the local carrier should be notified at once regarding his liability. A report should be submitted to the Product Service Department, Brooks Instrument, Hatfield, Pennsylvania 19440-0903.

Remove the envelope containing the packing list. Carefully remove the equipment from the packing case. Make sure spare parts are not discarded with the packing materials. Inspect for damaged or missing parts.

Brooks Instrument

407 W. Vine Street
P.O. Box 903
Hatfield, PA 19440 USA
Toll Free (888) 554-FLOW (3569)
Tel (215) 362-3700
Fax (215) 362-3745
E-mail: BrooksAm@BrooksInstrument.com
www.BrooksInstrument.com

Brooks Instrument

Neonstraat 3
6718 WX Ede, Netherlands
P.O. Box 428
6710 BK Ede, Netherlands
Tel 31-318-549-300
Fax 31-318-549-309
E-mail: BrooksEu@BrooksInstrument.com

Brooks Instrument

1-4-4 Kitasuna Koto-Ku
Tokyo, 136-0073 Japan
Tel 011-81-3-5633-7100
Fax 011-81-3-5633-7101
Email: BrooksAs@BrooksInstrument.com

2-2 Recommended Storage Practice

If intermediate or long-term storage is required for equipment as supplied by Brooks Instrument, it is recommended that said equipment be stored in accordance with the following:

- a. Within the original shipping container.
- b. Store in a sheltered area with the following conditions:
 1. Ambient temperature 21°C (70°F) nominal.
 2. Relative humidity 45% nominal, 60% maximum/25% minimum.
Upon removal from storage, a visual inspection should be conducted to verify its condition is "as received." If the equipment has been in storage for an excess of ten (10) months or in conditions in excess of those recommended, all pressure boundary seals should be replaced and the device subjected to a pneumatic pressure test in accordance with applicable vessel codes.

Brooks® Model 5860E

2-3 Return Shipment

Prior to returning any Brooks equipment to the factory, contact the factory - for a Return Materials Authorization Number (RMA#). This can be obtained at Brooks Instrument, Product Service Department, 407 West Vine Street, Hatfield, PA 19440-0903, or call toll free 1-888-554-FLOW (3569).

Brooks Instrument

407 W. Vine Street
P.O. Box 903
Hatfield, PA 19440 USA
Toll Free (888) 554-FLOW (3569)
Tel (215) 362-3700
Fax (215) 362-3745
E-mail: BrooksAm@BrooksInstrument.com
www.BrooksInstrument.com

Brooks Instrument

Neonstraat 3
6718 WX Ede, Netherlands
P.O. Box 428
6710 BK Ede, Netherlands
Tel 31-318-549-300
Fax 31-318-549-309
E-mail: BrooksEu@BrooksInstrument.com

Brooks Instrument

1-4-4 Kitasuna Koto-Ku
Tokyo, 136-0073 Japan
Tel 011-81-3-5633-7100
Fax 011-81-3-5633-7101
Email: BrooksAs@BrooksInstrument.com

Also, completion of Form RPR003-1, Brooks Instrument Decontamination Statement, as well as, a Material Safety Data Sheet (MSDS) for the fluid(s) used in the meter, is required before any Brooks Personnel can begin processing the equipment. Copies of the form can be obtained at one of the locations above.

2-4 Gas Connections

Standard inlet and outlet connections supplied on the Model 5860E are 1/4" compression fittings for flow rates up to 10 slpm, and 3/8" compression fittings for higher flow rates.

Optional VCO™ and VCR™ connections are available upon request. Prior to installation, make certain all piping is clean and free of obstructions. Install the piping in such a manner that permits easy removal if the instrument is to be removed for cleaning or test bench troubleshooting.

2-5 Installation (Refer to Figures 2-1 through 2-2)**⚠ CAUTION**

When installing the flowmeter, care should be taken that no foreign materials enter the inlet or outlet of the instrument. Do not remove the protective end caps until time of installation.

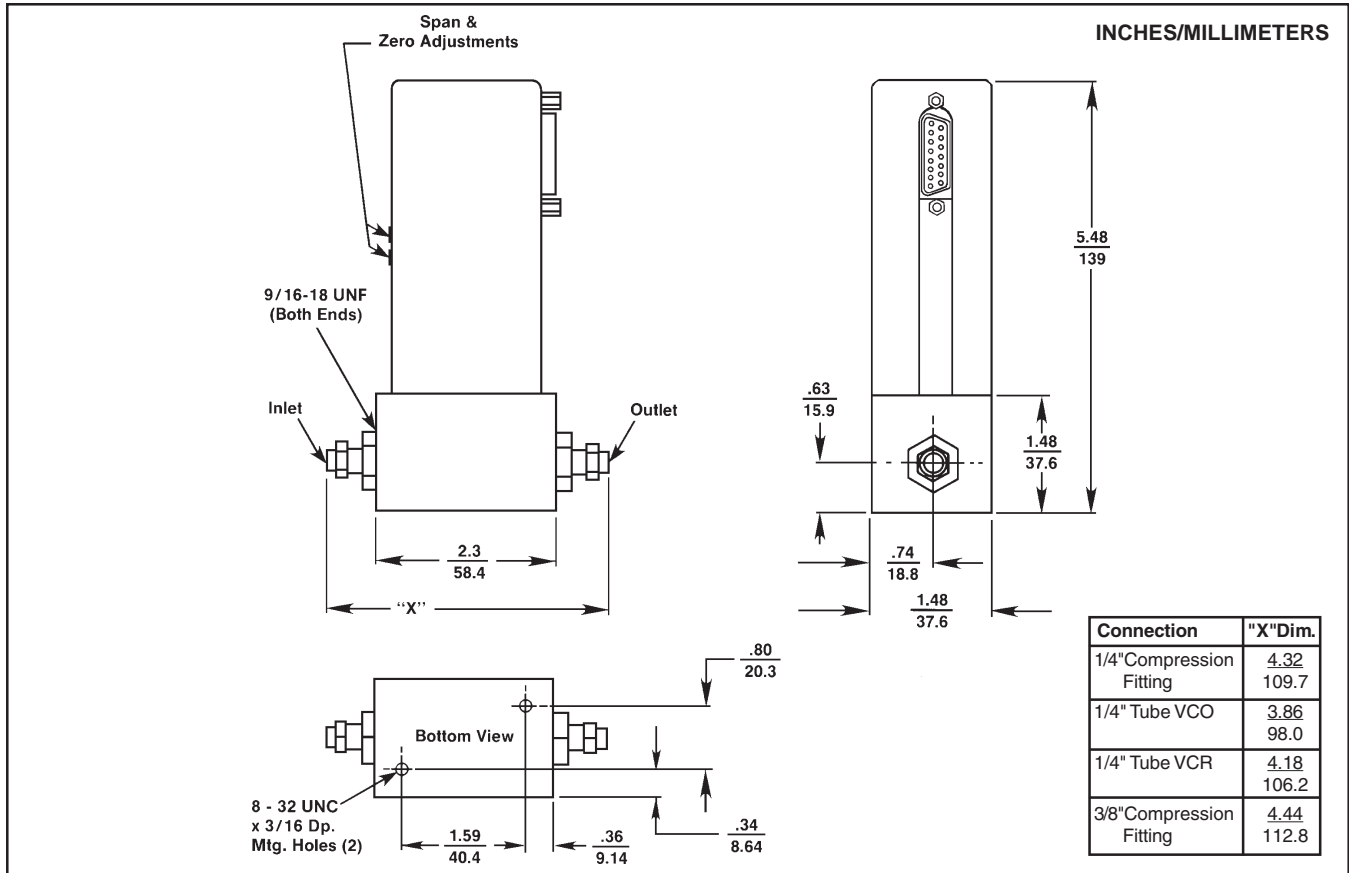

Figure 2-1 Model 5860E Dimensions

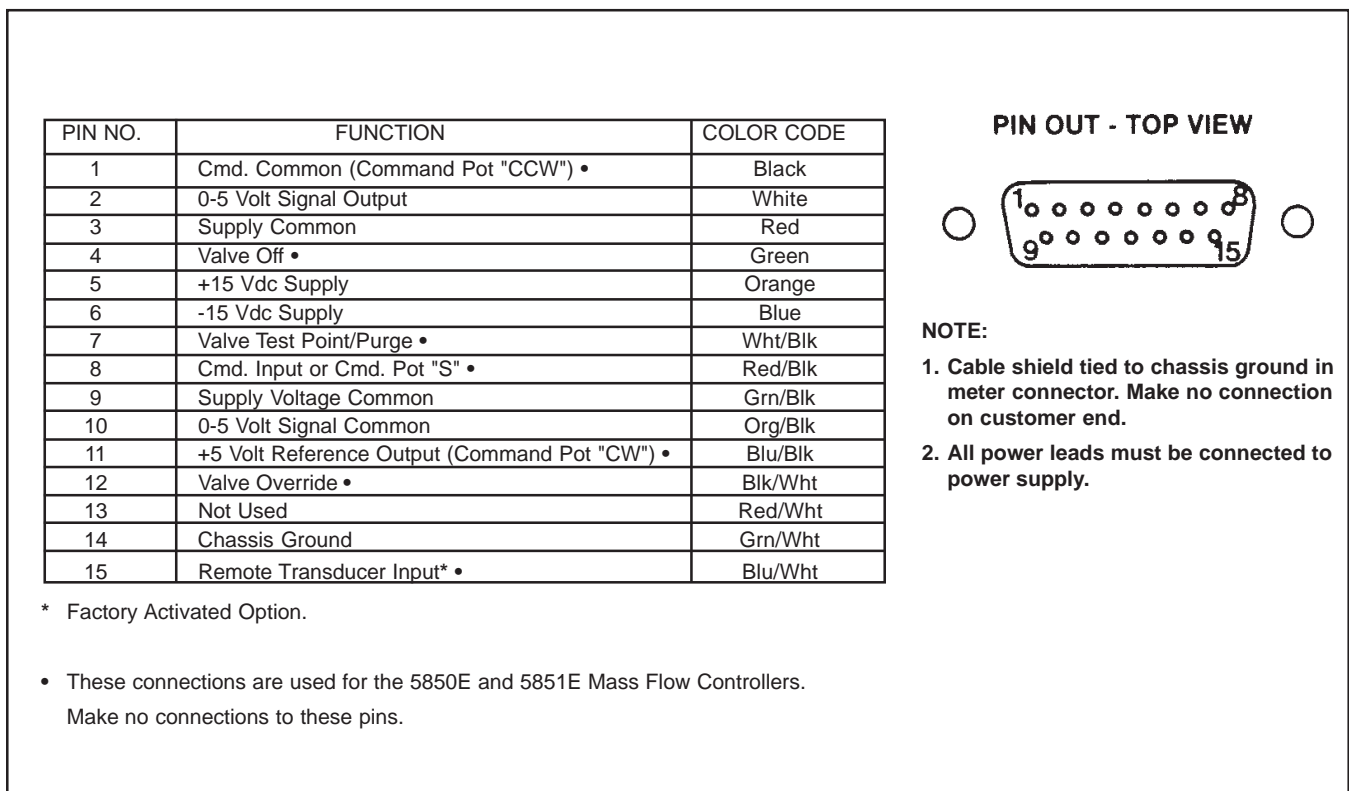

Figure 2-2 "D" Type Connector Pin Arrangement

⚠ CAUTION

Any Brooks Instrument mass flowmeter or flow controller with a 15 pin "D" Connector PC Board bearing the "CE Mark" must use a 100% shielded cable and metal shell mating connectors. The shield is tied over 360 degrees to the shell at both ends. This is mandatory to be in compliance with the EMC Directive (89/336/EEC).

Recommended installation procedures:

- a. The Model 5860E should be located in a clean dry atmosphere relatively free from shock and vibration.
- b. Leave sufficient room for access to the electrical components.
- c. Install in such a manner that permits easy removal if the instrument requires cleaning.

⚠ CAUTION

When used with a reactive (sometimes toxic) gas, contamination or corrosion may occur as a result of plumbing leaks or improper purging. Plumbing should be checked carefully for leaks and the meter purged with dry Nitrogen before use.

- d. The Model 5860E Mass Flow Meter can be installed in any position. However mounting orientations other than the original factory calibration (see data sheet) will result in a $\pm 0.5\%$ maximum full scale shift after re-zeroing.
- e. When installing flow meters be aware that sharp abrupt angles in the system piping directly upstream of the meter may cause a small shift in accuracy. If possible have at least 10 pipe diameters of straight tubing upstream of the Model 5860E Mass Flow Meter.

2-6 In-Line Filter

It is recommended that an in-line filter be installed upstream from the flowmeter to prevent the possibility of any foreign material entering the flow sensor. The filtering element should be replaced periodically or ultrasonically cleaned.

Table 2-1 Recommended Filter Size

Maximum Flow Rate	Recommended Filter Size
100 sccm	1 micron
500 sccm	2 micron
1 to 5 slpm	7 micron
10 to 30 slpm	15 micron

Note: The above Table lists the maximum recommended porosity for each flow range. It is recommended that the minimum micron porosity that does not limit the full scale flowrate be used.

2-7 Electrical Interfacing

To insure proper operation, the Model 5860E must be connected per Figure 2-2.

Note: There are several functions on the printed circuit board which are not used by the Model 5860E. Avoid making connections marked in Figure 2-2 which are marked •. Also, the plug-in jumpers on the printed circuit board are not used by the Model 5860E and have no effect on performance.

The following minimum electrical connections must be made for new installations:

- Chassis Ground
- 0-5 Volt Signal Common
- 0-5 Volt Signal Output
- +15 Vdc Supply
- 15 Vdc Supply

*THIS PAGE WAS
INTENTIONALLY
LEFT BLANK*

3-1 Theory of Operation

The thermal mass flow sensing technique used in the 5860E works as follows:

A precision power supply provides a constant power heat input (P) at the heater which is located at the midpoint of the sensor tube. (Refer to Figure 3-1) At zero or no flow conditions, the heat reaching each temperature sensor (one upstream and one downstream of the heater) is equal. Therefore, the temperatures T1 and T2 are equal. When gas flows through the tube, the upstream sensor is cooled and the downstream sensor is heated, producing a temperature difference. The temperature difference T2-T1 is directly proportional to the gas mass flow.

The equation is: $\Delta T = A * P * C_p * m$

Where,

ΔT	=	temperature difference T2 - T1 (°K)
C_p	=	specific heat of the gas at constant pressure (kJ/kg-°K)
P	=	heater power (kJ/s)
m	=	mass flow (kg/s)
A	=	constant of proportionality (S ² -°K ² /kJ ²)

A bridge circuit interprets the temperature difference and a differential amplifier generates a linear 0-5 Vdc signal directly proportional to the gas mass flow rate.

The flow restrictor shown in Figure 3-1 performs a ranging function similar to a shunt resistor in an electrical ammeter. The restrictor provides a pressure drop that is linear with flow rate. The sensor tube has the same linear pressure drop/flow relationship. The ratio of the restrictor flow to the sensor tube flow remains constant over the range of the meter. Different restrictors have different pressure drops and produce meters with different full scale flow rates. The span adjustment in the electronics affects the fine adjustment of the controller's full scale flow.

The Model 5860E has the following features incorporated in the integral control circuit:

Fast Response adjusted by the anticipate potentiometer. This circuit, when properly adjusted, allows the high frequency information contained in the sensor signal to be amplified to provide a faster responding flow signal for remote indication.

Removable cleanable sensor permits the user to clean or replace the sensor. Refer to Section 4-4.

Output Limiting prevents possible damage to delicate data acquisition devices by limiting the output to +6.8 Vdc and -.7 Vdc.

Brooks® Model 5860E

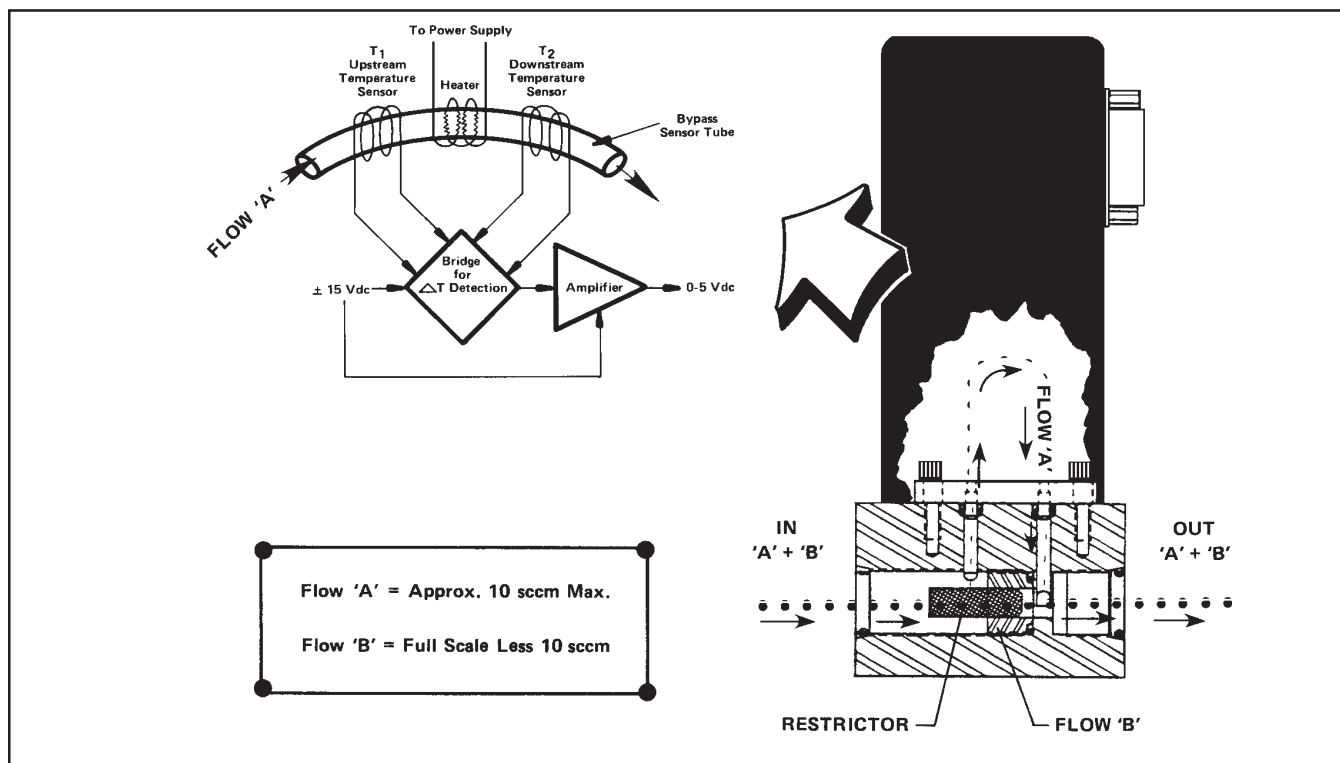

Figure 3-1 Flow Sensor Operational Diagram

3-2 Operating Procedure

- Apply power to the flowmeter and allow approximately 45 minutes for the instrument to warm-up and stabilize its temperature.
- Turn on the gas supply.
- Shut-off flow to the meter and observe the flowmeter's output signal. If the output is not 0mVdc (± 10 mVdc), check for leaks and if none are found, refer to the re-zeroing procedure in Section 3-3.
- Adjust for the desired flow and assume normal operation.

3-3 Zero Adjustment

Each Model 5860E is factory adjusted to provide a 0 ± 10 mVdc signal at zero flow. The adjustment is made in our calibration laboratory which is temperature controlled to 21.1°C ($70^\circ\text{F} \pm 2^\circ\text{F}$). After initial installation and warm-up in the gas system the zero flow indication may be other than the factory setting. This is primarily caused by changes in temperature between our calibration laboratory and the final installation. The zero flow reading can also be affected to a small degree by changes in line pressure and mounting attitude.

To check zero always mount the meter in its final configuration and allow a minimum of 45 minutes for the temperature of the meter and its environment to stabilize. Using a suitable voltmeter check the controller output signal. If it differs from the factory setting adjust it by removing the lower pot hole plug, which is located closest to the controller body. Adjust the zero potentiometer (refer to Figure 3-3) until the desired output signal is obtained.

3-4 Calibration Procedure

NOTE 1: Calibration of the Model 5860E mass flowmeter requires the use of a digital voltmeter (DVM) a flow control valve or mass flow controller to set the flow rate and a precision flow standard calibrator such as the Brooks Vol-U-Meter®. It is recommended that the calibration be performed only by trained and qualified service personnel.

NOTE 2: If the mass flowmeter is to be used on a gas other than the calibration gas, apply the appropriate sensor conversion factor.

- a. Adjust the anticipate potentiometer fully clockwise (20 turns). Then adjust the anticipate potentiometer 10 turns counterclockwise to center the potentiometer. This will provide a rough adjustment of this circuit and make the flow signal stable for calibration.
- b. Connect the DVM positive lead to the 0-5V signal output (terminal 3 card edge, pin 2 D-type) and the negative lead to signal common (TP4). Adjust the zero potentiometer for an output of 0mV ±2mV.
- c. Increase the flow rate until the flow signal output equals 5.000V. Connect the DVM positive lead to the 0.5V signal output (pin 2 of the "D" connector) and the negative lead to TP4. Connect the DVM positive lead to TP2 (linearity voltage) and the negative lead to TP4 (signal common). Adjust the linearity potentiometer for an output of 0.0V (zero volts).
- d. Connect the DVM positive lead to the 0-5V signal output (pin 2 of D-Connector) and the negative lead to TP4 (circuit common). Measure the flow rate using suitable volumetric calibration equipment. Adjust the flow rate to the proper full scale flow.

$$\text{Flow signal voltage} = \frac{\text{measured flow rate}}{\text{full scale flow rate}} \times 5.000$$

Adjust the span potentiometer until the voltage at pin 2 is 5.000V.

- e. Measure the voltage at TP1. The voltage at TPI is -100 times the output voltage of the sensor. This voltage can range from -1.2 to -12 volts, however it is recommended that this voltage stays between -2.0 and -9.0 volts for proper operation. If the recommended voltage range exceeds this then the desired accuracy and/or signal stability may not be achieved. If one of the limits is reached check the restrictor sizing procedures. Refer to Section 4-6.
- f. Shut off the flow. Connect the DVM positive lead to flow signal output (pin 2 D-type) and the negative lead to TP4. Readjust the zero potentiometer for an output of 0mV± 2mV as necessary.
- g. Flow rate for a flow signal output of 50% (2.500V) and measure the flow rate. Calculate the error as a percentage of full scale.

Brooks® Model 5860E

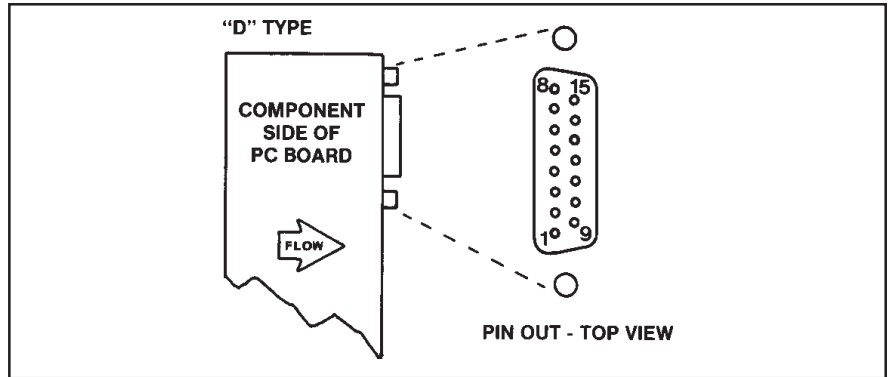

Figure 3-2 Model 5860E Calibration Connections

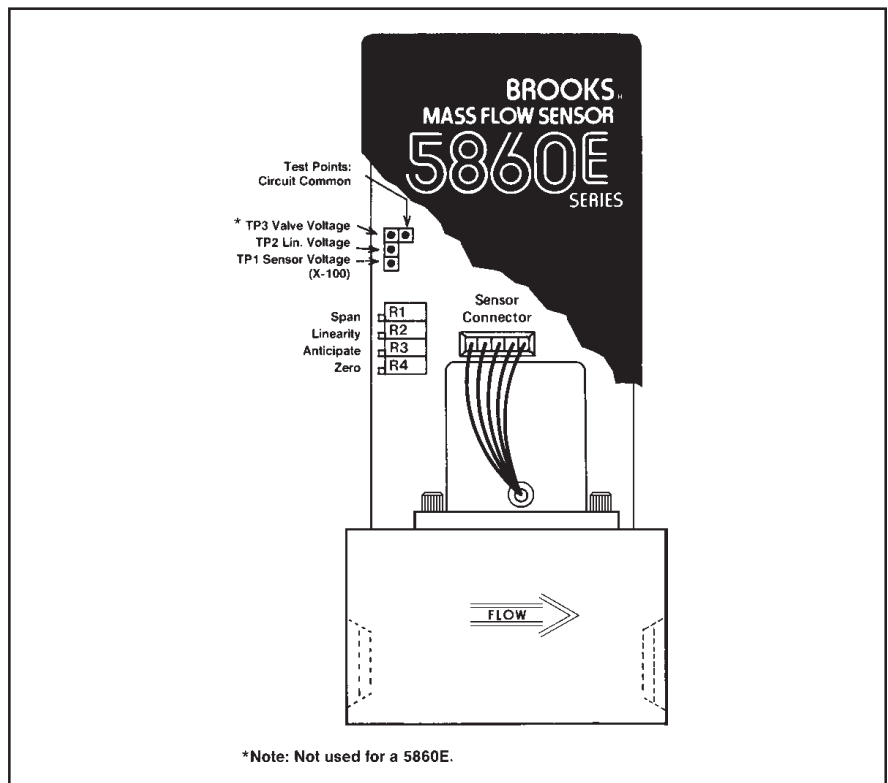
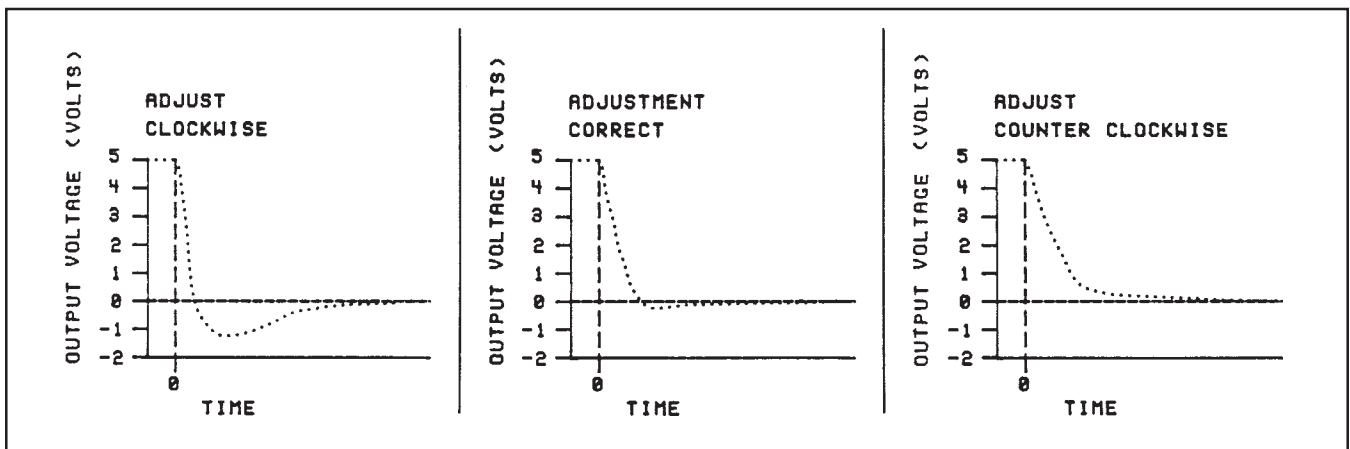

Figure 3-3 Adjustment Potentiometer Location



3-4 Figure 3-4 Fast Response Adjustment

$$\text{full scale error} = 100\% \frac{\text{indicated flow rate} - \text{measured flow rate}}{\text{full scale flow rate}}$$

Example:

What is the percent of full scale error when full scale is equal to 100 sccm?

Measured flow rate = 50.0 sccm

Indicated flow rate = 48.5 sccm

$$\text{Full Scale Error} = 100 \frac{(48.5 - 50)}{100} = -1.5\%$$

h. Calculate the TP2 correction voltage:
 (error recorded in step g) x 0.450 volts

Example:

Error = -1.5%

TP2 correction voltage = -1.5 x 0.450 = -0.675 volts

New TP2 voltage = 0 volts + (-0.675) = -0.675 volts

i. Flow rate for a flow signal output of 100% (5.000V). Connect the DVM positive lead to TP2 and the negative lead to TP4.

j. Adjust the linearity potentiometer for an output equal to the new calculated TP2 voltage.

k. Repeat steps d, e, f, and g.

1. If the error recorded in step g is less than 0.5%, then the calibration procedure is complete.

2. If the error is greater than 0.5% set the flow rate for a flow signal output of 100% (5.000V). Connect the DVM positive lead to TP2 (linearity voltage) and the negative lead to TP4 (circuit common).

Calculate a new TP2 voltage as follows:

$$\text{New TP2 voltage} = \frac{\text{error recorded in Step i}}{\text{Step i}} \times 0.450\text{V} + \text{measured TP2 voltage}$$

Example:

Sensor error = 0.7%

Measured TP2 voltage = -0.567 volts

TP2 correction = 0.7 x 0.450 = 0.315 volts

New TP2 correction = 0.315 + (-0.567) = -0.252 volts

Adjust the linearity potentiometer for an output equal to the new TP2 voltage and then repeat steps f, g and h.

Note: The voltage at TP2 can range from -10 to +3 volts, however, it is recommended that this voltage stay between -2.5 and +2.5 volts for proper operation. If the recommended voltage range is exceeded the desired accuracy and/or signal stability may not be achieved. If one of the limits is reached, check the restrictor sizing. Refer to Section 4-6.

Brooks® Model 5860E

3-5 Response (Flow Output Signal)

To achieve the proper response characteristics the response compensation circuit must be adjusted. This adjustment is performed by observing the output signal of the meter when the flow is suddenly stopped. Place a metering valve upstream of the Model 5860E to control the flow rate. A Brooks NRS® precision metering valve is well suited for this application. Also place a fast acting shut-off valve immediately downstream of the flowmeter. A solenoid valve is ideal for this, but a manual toggle valve will do. Keep the length of interconnecting tubing as short as possible between the valves and the Model 5860E since the tubing can have a dampening effect on the flow and the gas may not stop flowing the instant the downstream valve is closed as desired. Adjustment of the fast response circuit will not alter the steady state accuracy of the flowmeter as adjusted in Section 3-4.

Note: This procedure requires an oscilloscope, chart recorder, or a DVM with a sample speed three samples per second or greater to monitor the rate of change of the output signal during the test. Monitor the output signal at pin 2 of D-Connector. TP4 may be used for ground.

- a. With the shut-off valve open adjust the metering valve so that the output voltage of the Model 5860E is 4.050 to 5.000 Vdc. Allow the output to become stable at this setting.
- b. Close the shut off valve to stop the flow. Observe the output signal as it decays.
- c. The behavior of the output signal during the transition between 100% and 0% flow indicates the adjustment required of the anticipate potentiometer. Refer to Figure 3-4.
 1. If the flow signal decays to -0.05 to -0.5V then rises to 0.0V, the anticipate potentiometer is properly adjusted.
 2. If the flow signal decays rapidly and goes below -0.5V before rising to 0.0V, the anticipate potentiometer must be adjusted clockwise and steps a and b repeated.
 3. If the flow signal decays slowly and does not go below -0.05V, the anticipate potentiometer must be adjusted counterclockwise and steps a and b repeated.

4-1 General

No routine maintenance is required on the Model 5860E other than an occasional cleaning. If an in-line filter is used, the filtering element should periodically be replaced or ultrasonically cleaned.

4-2 Troubleshooting

⚠ CAUTION

It is important that this flowmeter be serviced only by properly trained and qualified personnel.

A. System Checks

The Model 5860E is generally used as a component in gas handling systems which can be quite complex. This can make the task of isolating a malfunction in the system a difficult one. An incorrectly diagnosed malfunction can cause many hours of unnecessary downtime. If possible, make the following system checks before removing a suspected defective mass flowmeter for bench troubleshooting or return, especially if the system is new:

⚠ WARNING

If it becomes necessary to remove the flowmeter from the system after exposure to toxic, pyrophoric, flammable, or corrosive gas, purge the flowmeter thoroughly with a dry inert gas such as Nitrogen, before disconnecting the gas connections. Failure to correctly purge the flowmeter could result in fire, explosion, or death. Corrosion or contamination of the mass flowmeter upon exposure to air may also occur.

B. Bench Troubleshooting

1. Properly connect the mass flowmeter to a ± 15 Vdc power supply, and connect an output signal readout device (4-1/2 digit voltmeter recommended) to terminals 2 and 3 (D-type pins 2 and 10) (Refer to Figure 2-2). Apply power, and allow the flowmeter to warm up for 45 minutes. Do not connect to a gas source at this time. Observe the output signal and, if necessary perform the zero adjustment procedure (Section 3-3). If the output signal will not zero properly, refer to the sensor troubleshooting section and check the sensor. If the sensor is electrically functional, the printed circuit board is defective and will require replacement.
2. Connect the flowmeter to a source of the gas on which it was originally calibrated. Increase the flow until 100% indication (5.00Vdc) is achieved. Vary the flow rate over the 2 to 100% range and verify that the output signal follows the flow rate. If possible, connect a flow measurement device in series with the mass flowmeter to observe the actual flow behavior and verify the accuracy of the mass flowmeter. If the mass flowmeter functions as described above, it is functioning properly and the problem may lie elsewhere.

Brooks® Model 5860E

Table 4-1 Bench Troubleshooting

Trouble	Possible Cause	Check/Corrective Action
Output stays at 0 Volts regardless of flow.	Clogged Sensor.	Clean sensor. Refer to cleaning procedure. Section 4-4.
Output signal stays at +6.8V and there is no flow through the meter.	Defective PC Board. Defective Sensor.	Replace PC Board. Refer to Section 4-4. Replace Sensor Assembly. Refer to Section 4-4.
Meter grossly out of calibration. Flow is higher than indicated.	Partially clogged sensor.	Clean sensor, refer to the cleaning procedure.
Meter grossly out of calibration. Flow is lower than indicated.	Partially clogged restrictor.	Replace restrictor. Refer to Section 4-4.
Meter output oscillates.	Anticipate potentiometer out of adjustment. Faulty pressure regulator. Defective PC Board.	Adjust anticipate potentiometer. Refer to Section 3-4. Check regulator output. Replace PC Board. Refer to Section 4-4.

Table 4-2 Sensor Troubleshooting

SENSOR SCHEMATIC

WIRE COLOR	PIN NO.	FUNCTION
White	4	Sensor common
Yellow	1	Heater
Blue	5	Heater common
Red	2	Upstream temperature sensor (Su)
Black	3	Downstream temperature sensor (Sd)

Flex Circuit Wire Numbers

Note: Sensors manufactured before 9/88 used a wire harness interconnect, newer sensors use a "Flex" cable.

OHMMETER CONNECTION	RESULT IF ELECTRICALLY FUNCTIONAL
Yellow and white to body (ground) (Pin 1 or 4 to body)	Open circuit on ohmmeter. If either heater (yellow), or sensor common (white) are shorted, an ohmmeter reading will be obtained.
White to red (Pin 4 to Pin 2)	Nominal 1100 ohms reading.
White to black (Pin 4 to Pin 3)	Depending on temperature and ohmmeter current.
Blue to yellow (Pin 5 to Pin 1)	Nominal 1200 ohm reading.

Note: Remove the sensor connector from the PC Board for this procedure.

Table 4-1 lists possible malfunctions which may be encountered during bench troubleshooting.

C. Sensor Troubleshooting

If it is believed the sensor coils are either open or shorted, troubleshoot using Table 4-2. If any of the steps do not produce the expected results the sensor assembly is defective and must be replaced. Refer to Section 4-4 for the disassembly and assembly procedures to use when replacing the sensor.

Note: Do not attempt to disassemble the sensor.

D. Cleaning Procedures

Should the Model 5860E Mass Flow Meter require cleaning due to deposition, use the following procedures:

1. Remove the unit from the system.
2. Refer to Section 4-4 to disassemble the flowmeter.

⚠ CAUTION

Do not soak the sensor assembly in a cleaning solution. If solvent seeps into the sensor assembly, it will probably damage the sensor, or, at least, significantly alter its operating characteristics.

3. Use a hemostat or tweezers to push a 0.007" dia. piano wire through the flow sensor tube to remove any contamination. For best results push the wire into the downstream opening of the sensor tube. The sensor tube can be flushed with a non-residuous solvent (Freon TF® recommended). A hypodermic needle filled with solvent is a convenient means to accomplish this.

An alternate method for flushing out the sensor is to replace the restrictor element with a low flow plug restrictor. This plug forces all the flow through the sensor and may dislodge any obstructions. Subject the flow meter to a high differential pressure. Pressurizing the outlet of the flowmeter higher than the inlet may help force the obstruction upstream and out of the sensor tube.

4. Deposits of silicon dioxide may be removed by soaking the internal parts in solution of 5% of hydrofluoric acid (5 parts hydrofluoric acid (HF), 95 parts water (H₂O)) followed by Freon TF.
5. Sintered type restrictor elements should be replaced as it is not always possible to adequately remove deposits from them. Wire mesh and A.C.L.F.E. type restrictor elements can be cleaned in an ultrasonic bath. Refer to Section 4-7 for the correct restrictor to use.
6. Blow all parts dry with dry Nitrogen and reassemble. Refer to Section 4-4b (assembly).
7. Purge the assembled controller with dry Nitrogen.
8. Perform the calibration procedure in Section 3-4.
9. When the flowmeter is reinstalled in the system, the connections should be leak tested and the system should be purged with dry Nitrogen for 30 minutes prior to start-up to prevent the formation of deposits.

Brooks® Model 5860E

4-3 Sensor Tube

The sensor tube is part of a calibrated flow divider that is designed to operate within a preset gas flow range. The sensor assembly may be removed or replaced by referring to Section 4-4, Disassembly and Assembly. If the sensor assembly is cleaned and reinstalled, a calibration check should be performed. Refer to Section 3-4.

4-4 Disassembly and Assembly

Note: The Model 5860E Mass Flow Meter may be disassembled and assembled in the field by the user for cleaning, reranging or servicing. Disassemble and reassembly the meter as follows:

A. Disassembly

The numbers in () refer to the spare parts exploded view in Figure 5-1.

⚠ CAUTION

Do not attempt to disassemble the mass flowmeter until pressure has been removed and purging has been performed. Hazardous gas may be trapped in the valve assembly which could result in explosion, fire, or serious injury.

1. Remove the three screws (8) attaching the electronics cover and loosen the upper jack post on the D-Connector. Remove the electronics cover (11).

⚠ CAUTION

Be careful not to stress the sensor lead wire to sensor assembly junction when removing the sensor connector from the PC board. If the sensor lead wires are stressed an open in the sensor wiring could result.

2. Unplug the sensor connector from the PC Board. Remove the two screws securing the bracket (13) and PC Board (2). Remove the bracket and PC Board.
3. Remove the two screws (6) and washers (7) securing the sensor assembly (3). Remove the sensor assembly.

Note: Do not attempt to disassemble the sensor assembly.

⚠ CAUTION

Do not scratch the O-ring sealing surface.

4. Remove the backup rings (5) and the sensor assembly O-rings (4) from the flowmeter body (1). Using the Brooks O-ring removal tool will help prevent scratching the sealing surface.
5. Remove the adapter fittings (15) from the flowmeter body (1).
6. Remove the restrictor assembly (9) from the inlet side of the flowmeter body (1) using the restrictor tool (part of service tool kit listed in Section 5, Table 5-2).

B. Assembly

CAUTION

Do not get Halocarbon lubricant on the restrictor element (9) or hands. This is a special inert lubricant which is not easily removed.

Note: It is recommended that all O-rings be replaced during flowmeter assembly. All O-rings should be lightly lubricated with Halocarbon lubricant (part of O-ring kit, Section 5) prior to their installation.

1. Examine all parts for signs of wear or damage, replace as necessary.
2. Place the restrictor O-ring on the restrictor assembly. Screw the restrictor assembly (9) into the inlet side of the flowmeter body using the restrictor tool, tighten hand tight.

CAUTION

The following steps must be performed as written. Placing the O-rings on the sensor before it is installed will result in damage to the O-rings causing a leak.

3. Press the lubricated sensor O-rings (4) into the flowmeter body (1). Press the back up rings (5) into the O-ring cavity above the O-rings. Be sure that the O-rings are seated square and the backup rings are below the surface of the body. The back end of the O-ring removal tool is useful to press the backup rings all the way into the body.
4. Install the sensor assembly (3) as shown in Figure 5-1 and secure with the two socket head cap screws (6) and washers (7). Tighten the screws to 18 +2/-4 in-lbs.
5. Install the printed circuit board (2), secure with bracket (13) and two screws (8). Plug the connector from the sensor assembly (3) onto the PC Board. The flow arrow on the connector should be pointing in the direction of the flow.
6. Install the electronics cover (11) on the controller and secure with three screws (8). Tighten the upper jack post on the D-Connector.
7. Prior to installation leak and pressure test, the assembled flowmeter to any applicable pressure vessel codes.

Brooks® Model 5860E

4-5 Use of the Conversion Tables

If a mass flowmeter is operated on a gas other than the gas it was calibrated with, a scale shift will occur in the relationship between the output signal and the mass flow rate. This is due to the difference in heat capacities between the two gases. This scale shift can be approximated by using the ratio of the molar specific heat of the two gases, or sensor conversion factor. A list of sensor conversion factors is given in Table 4-3. To change to a new gas, multiply the output reading by the ratio of the gas factor for the desired gas to the gas factor for the calibration gas.

$$\text{Actual gas flow rate} = \text{Output reading} \times \frac{\text{factor of the new gas}}{\text{factor of the calibrated gas}}$$

Example:

The flowmeter is calibrated for Nitrogen.

The desired gas is Carbon Dioxide.

The output reading is 75 sccm when Carbon Dioxide is flowing.

Then $75 \times 0.78 = 58.50$ sccm

In order to calculate the conversion factor for a gas mixture, the following formula should be used:

$$\text{Sensor Conversion Factor Mixture} = \frac{100}{\frac{P_1}{\text{Sensor Conversion Factor 1}} + \frac{P_2}{\text{Sensor Conversion Factor 2}} + \frac{P_n}{\text{Sensor Conversion Factor n}}}$$

Where,

P1 = percentage (%) of gas 1 (by volume)

P2 = percentage (%) of gas 2 (by volume)

Pn = percentage (%) of gas n (by volume)

Example: The desired gas is 20% Helium (He) and 80% Chlorine (Cl) by volume. The desired full scale flow rate of the mixture is 20 slpm.

Sensor conversion factor for the mixture is:

$$\text{Mixture Factor} = \frac{100}{\frac{20}{1.39} + \frac{80}{.83}} = .903$$

$$\text{Air equivalent flow} = 20/.903 = 22.15 \text{ slpm air}$$

It is generally accepted that the mass flow rate derived from this equation is only accurate to $\pm 5\%$. The sensor conversion factors given in Table 4-3 are calculated based on a gas temperature of 21°C and a pressure of one atmosphere. The specific heat of most gases are not strongly pressure and temperature dependent, however gas conditions that vary widely from these reference conditions may cause an additional error due to the change in specific heat due to temperature and/or pressure.

Table 4-3 Conversion Factors (Nitrogen Base) Ref. No. J836D508.

GAS NAME	FORMULA	SENSOR FACTOR	ORIFICE FACTOR	DENSITY (kg/m ³)
Acetylene	C ₂ H ₂	0.615	0.970	1.173
Air	Mixture	0.998	1.018	1.293
Allene	C ₃ H ₄	0.478	1.199	1.787
Ammonia	NH ₃	0.786	0.781	0.771
Argon	Ar	1.395	1.195	1.784
Arsine	AsH ₃	0.754	1.661	3.478
Boron Trichloride	BCL ₃	0.443	2.044	5.227
Boron Trifluoride	BF ₃	0.579	1.569	3.025
Bromine Pentafluoride	BrF ₅	0.287	2.502	7.806
Bromine Trifluoride	BrF ₃	0.439	2.214	6.108
Bromotrifluoroethylene	C ₂ BrF ₃	0.326	2.397	7.165
Bromotrifluoromethane f-13B1	CBrF ₃	0.412	2.303	6.615
1,3-Butadiene	C ₄ H ₆	0.354	1.413	2.491
Butane	C ₄ H ₁₀	0.257	1.467	2.593
1-Butene	C ₄ H ₈	0.294	1.435	2.503
CIS-2-Butene	C ₄ H ₈	0.320	1.435	2.503
Trans-2-Butene	C ₄ H ₈	0.291	1.435	2.503
Carbon Dioxide	CO ₂	0.773	1.255	1.977
Carbon Disulfide	CS ₂	0.638	1.650	3.393
Carbon Monoxide	CO	0.995	1.000	1.250
Carbon Tetrachloride	CCL ₄	0.344	2.345	6.860
Carbon Tetrafluoride f-14	CF ₄	0.440	1.770	3.926
Carbonyl Fluoride	COF ₂	0.567	1.555	2.045
Carbonyl Sulfide	COS	0.680	1.463	2.180
Chlorine	CL ₂	0.876	1.598	3.214
Chlorine Dioxide	CLO ₂	0.693	1.554	3.011
Chlorine Trifluoride	CLF ₃	0.433	1.812	4.125
2-Chlorobutane	C ₄ H ₉ Cl	0.234	1.818	4.134
Chlorodifluoromethane f-22	CHCLF ₂	0.505	1.770	3.906
Chloroform (Trichloromethane)	CHCL ₃	0.442	2.066	5.340
Chloropentafluoroethane f-115	C ₂ CLF ₅	0.243	2.397	7.165
Chlorotrifluoroethylene	C ₂ CLF ₃	0.337	2.044	5.208
Chlorotrifluoromethane f-13	CCLF ₃	0.430	1.985	4.912
Cyanogen	(CN) ₂	0.498	1.366	2.322
Cyanogen Chloride	CLCN	0.618	1.480	2.730
Cyclobutane	C ₄ H ₈	0.387	1.413	2.491
Cyclopropane	C ₃ H ₆	0.505	1.224	1.877
Deuterium	D ₂	0.995	0.379	0.177
Diborane	B ₂ H ₆	0.448	1.000	1.235
Diboromodifluoromethane f-12B2	CBr ₂ F ₂	0.363	2.652	8.768
1,2-Dibromotetrafluoroethane f-114B2	C ₂ Br ₂ F ₄	0.215	2.905	10.53
Dichlorodifluoromethane f-12	CCL ₂ F ₂	0.390	2.099	5.492
Dichlorofluoromethane f-21	CHCL ₂ F	0.456	1.985	4.912
Dichlorosilane	SiH ₂ CL ₂	0.442	1.897	4.506
1,2-Dichloroethane	C ₂ H ₄ CL ₂	0.382	1.879	4.419
1,2-Dichlorotetrafluoroethane f-114	C ₂ CL ₂ F ₄	0.231	2.449	7.479
2,2 Dichloro	C ₂ HCL ₂ F ₃	0.259	2.336	6.829
1,1-Difluoro-1-Chloroethane	C ₂ H ₃ CLF ₂	0.341	1.957	4.776
1,1-Difluoroethane	CH ₂ CHF ₂	0.415	1.536	2.940
1,1-Difluoroethylene	CH ₂ CF ₂	0.458	1.512	2.860
Diethylsilane	C ₄ H ₁₂ Si	0.183	1.775	3.940
Difluoromethane f-32	CF ₂ H ₂	0.627	1.360	2.411
Dimethylamine	(CH ₃) ₂ NH	0.370	1.269	2.013
Dimethylether	(CH ₃) ₂ O	0.392	1.281	2.055
2,2-Dimethylpropane	C(CH ₃) ₄	0.247	1.613	3.244
Disilane	Si ₂ H ₆	0.332	1.493	2.779
Ethane	C ₂ H ₆	0.490	1.038	1.357
Ethanol	C ₂ H ₅ O	0.394	1.282	2.057
Ethylacetylene	C ₄ H ₆	0.365	1.384	2.388
Ethyl Chloride	C ₂ H ₅ CL	0.408	1.516	2.879
Ethylene	C ₂ H ₄	0.619	1.000	1.261
Ethylene Oxide	C ₂ H ₄ O	0.589	1.254	1.965
Fluorine	F ₂	0.924	1.163	1.695
Fluoroform f-23	CHF ₃	0.529	1.584	3.127
Germane	GeH ₄	0.649	1.653	3.418
Germanium Tetrachloride	GeCl ₄	0.268	2.766	9.574
Halothane (R-123B1)	C ₂ HBrClF ₃	0.257	2.654	8.814
Helium	He	1.386	0.378	0.178
Hexafluoroacetone	F ₃ CCOCF ₃	0.219	2.434	7.414
Hexafluorobenzene	C ₆ F ₆	0.632	2.577	8.309
Hexafluoroethane f-116	C ₂ F ₆	0.255	2.219	6.139
Hexafluoropropylene (HFP)	C ₃ F ₆	0.249	2.312	6.663
Hexamethyldisilane (HMDS)	(CH ₃) ₆ Si ₂	0.139	2.404	7.208
Hexane	C ₆ H ₁₄	0.204	1.757	3.847

Brooks® Model 5860E

Table 4-3 Conversion Factors (Nitrogen Base) Ref. No. J836D508 Continued.

GAS NAME	FORMULA	SENSOR FACTOR	ORIFICE FACTOR	DENSITY (kg/m ³)
Hydrogen	H ₂	1.008	0.269	0.090
Hydrogen Bromide	HBr	0.987	1.695	3.645
Hydrogen Chloride	HCL	0.983	1.141	1.639
Hydrogen Cyanide	HCN	0.744	0.973	1.179
Hydrogen Fluoride	HF	0.998	0.845	0.893
Hydrogen Iodide	HI	0.953	2.144	5.789
Hydrogen Selenide	H ₂ Se	0.837	1.695	3.613
Hydrogen Sulfide	H ₂ S	0.850	1.108	1.539
Iodine Pentafluoride	IF ₅	0.283	2.819	9.907
Isobutane	C ₄ H ₁₀	0.260	1.440	2.593
Isobutene	C ₄ H ₈	0.289	1.435	2.503
Isopentane	C ₅ H ₁₂	0.211	1.605	3.222
Krypton	Kr	1.382	1.729	3.708
Methane	CH ₄	0.763	0.763	0.717
Methylacetylene	C ₃ H ₄	0.473	1.196	1.782
Methyl Bromide	CH ₃ Br	0.646	1.834	4.236
3-Methyl-1-butene	C ₅ H ₁₀	0.252	1.584	3.127
Methyl Chloride	CH ₃ CL	0.687	1.347	2.308
Methyl Fluoride	CH ₃ F	0.761	1.102	1.518
Methyl Mercaptan	CH ₃ S	0.588	1.313	2.146
Methyl Silane	CH ₃ Si	0.393	1.283	2.061
Methyl Trichlorosilane (MTS)	CH ₃ Cl ₃ Si	0.267	2.310	6.675
Methyl Vinyl Ether	C ₂ H ₄ O	0.377	1.435	2.567
Monoethanolamine	C ₂ H ₇ NO	0.305	1.477	2.728
Monoethylamine	C ₂ H ₅ NH ₂	0.359	1.269	2.013
Monomethylamine	CH ₃ NH ₂	0.565	1.067	1.420
Neon	Ne	1.398	0.847	0.902
Nickel Carbonyl	Ni(CO) ₄	0.212	2.371	7.008
Nitric Oxide	NO	0.995	1.030	1.339
Nitrogen	N ₂	1.000	1.000	1.251
Nitrogen Dioxide	NO ₂	0.758	1.713	2.052
Nitrogen Trifluoride	NF ₃	0.501	1.598	3.168
Nitrogen Trioxide	N ₂ O ₃	0.443	1.649	3.389
Nitrosyl Chloride	NOCL	0.644	1.529	2.913
Nitrous Oxide	N ₂ O	0.752	1.259	1.964
Octofluorocyclobutane	C ₄ F ₈	0.169	2.672	8.933
Oxygen	O ₂	0.988	1.067	1.429
Oxygen Difluoride	OF ₂	0.672	1.388	2.402
Ozone	O ₃	0.738	1.310	2.138
Pentafluoroethane f-125	C ₂ HF ₅	0.287	2.070	5.360
Pentane (n-Pentane)	C ₅ H ₁₂	0.212	1.605	3.222
Perchloryl Fluoride	CLO ₃ F	0.448	1.905	4.571
Perfluorobutane	C ₄ F ₁₀	0.738	2.918	10.61
Perfluoro-2-Butene	C ₄ F ₈	0.268	2.672	8.933
Perfluoromethyl-vinylether	PMVE	0.296	2.029	5.131
Perfluoropropane	C ₃ F ₈	0.179	2.591	8.396
Pentane (n-Pentane)	C ₅ H ₁₂	0.212	1.605	3.222
Phosgene	COCL ₂	0.504	1.881	4.418
Phosphine	PH ₃	0.783	1.100	1.517
Phosphorous Pentafluoride	PF ₅	0.346	2.109	5.620
Phosphorous Trifluoride	PF ₃	0.495	1.770	3.906
Propane (same as CH ₃ CH ₂ CH ₃)	C ₃ H ₈	0.343	1.274	2.008
Propylene (Propene)	C ₃ H ₆	0.401	1.234	1.875
Rhenium Hexafluoride	ReF ₆	0.230	3.279	13.41
Silane	SiH ₄	0.625	1.070	1.440
Silicon Tetrachloride	SiCL ₄	0.310	2.465	7.579
Silicon Tetrafluoride	SiF ₄	0.395	1.931	4.648
Sulfur Dioxide	SO ₂	0.728	1.529	2.858
Sulfur Hexafluoride	SF ₆	0.270	2.348	6.516
Sulfur Tetrafluoride	SF ₄	0.353	1.957	4.776
Sulfur Trioxide	SO ₃	0.535	1.691	3.575
Sulfuryl Fluoride	SO ₂ F ₂	0.423	1.931	4.648
Tetrachloromethane	CCL ₄	0.344	2.345	6.858
Tetrafluoroethylene (TFE)	C ₂ F ₄	0.361	1.905	4.526
Tetrafluorohydrazine	N ₂ F ₄	0.367	1.926	4.624
Trichlorofluoromethane f-11	CCL ₃ F	0.374	2.244	6.281
Trichlorosilane	SiHCL ₃	0.329	2.201	6.038
Trimethylxyborane (TMB)	B(OCH ₃) ₃	0.300	1.929	4.638
1,1,2-Trichloro-1,1,2-Trifluoroet f-113	C ₂ CL ₃ F ₃	0.231	2.520	7.920
Trimethylamine	(CH ₃) ₃ N	0.316	1.467	2.639
Tungsten Hexafluoride	WF ₆	0.227	3.264	13.28
Uranium Hexafluoride	UF ₆	0.220	3.548	15.70
Vinyl Bromide	C ₂ H ₃ Br	0.524	1.985	4.772
Vinyl Chloride	C ₂ H ₃ CL	0.542	1.492	2.788
Vinyl Fluoride	C ₂ H ₃ F	0.576	1.281	2.046
Water Vapor	H ₂ O	0.861	0.802	0.804
Xenon	Xe	1.383	2.180	5.851

4-6 Restrictor Sizing

The restrictor assembly is a ranging device for the sensor portion of the flowmeter. It creates a pressure drop which is linear with flow rate. This diverts a sample quantity of the process gas flow through the sensor. Each restrictor maintains the ratio of sensor flow to restrictor flow, however the total flow through each restrictor is different. Different restrictors (micron porosity and active area) have different pressure drops and produce meters with different full scale flow rates. For a discussion of the interaction of the various parts of the meter, you are urged to review Section 3-1 (Theory of Operation).

If the restrictor assembly has been contaminated with foreign matter, the pressure drop vs. flow characteristics will be altered and it must be cleaned or replaced. It may also be necessary to replace the restrictor assembly when the mass flowmeter is to be calibrated to a new full scale flow rate.

Restrictor assembly replacement should be performed only by trained personnel. The tools required for the removal/replacement procedure are as follows:

- Appropriate size wrench for the removal of the inlet process connection.
- Restrictor removal tool (contained in service tool kit P/N S-778-D-017-AAA)
- Restrictor O-ring, refer to the spare parts Section 5, for the correct part number.

Restrictors

The Model 5860E Series Mass Flowmeters use three types of restrictor assemblies depending on full scale flowrate and expected service conditions.

1. Porous sintered metal for air equivalent flow rates up to and including 9.5 slpm. The porosity ranges from 1-40 microns. This type of assembly is least expensive and should be used when the gas stream will not contain any particulate matter.
2. Sintered wire mesh for air equivalent flow rates above 3.5 slpm. These restrictor assemblies are made from a cylinder of sintered wire mesh and are easily cleaned if they become contaminated in service.
3. Anti-Clog Laminar Flow Element (ACLFE). This type of restrictor assembly is used for air equivalent flow rates less than 3.4 slpm the ACLFE is much more tolerant to particulate contamination than the sintered metal assembly. This is especially important when handling semiconductor gases that tend to precipitate particles. The ACLFE will also improve accuracy when operating at very low pressures.

Sizing

All Model 5860E Series restrictor assemblies are factory adjusted to provide a 115 mm water column pressure drop for a specific flow rate. This corresponds to the desired full scale flow rate. A list of restrictor assemblies used in the Model 5860E Series Mass Flowmeters is shown in Table 4-4.

Brooks® Model 5860E

Example:

The desired gas is Silane (SiH_4).

The desired full scale flow rate is 200 sccm.

Sensor conversion factor is 0.68 from Table 4-3.

Air equivalent flow = $200/0.68 = 294.1$ sccm air.

In the example above a size P restrictor would be selected. Both the sintered metal and ACLFE are available for this size. Either type will work however, since Silane is known to precipitate silicon dioxide particles when contaminated an anti-clog laminar flow element should be selected for this application.

NOTE: If the calculated flow rate is such that two different size restrictors could be used, always select the larger size.

If a mixture of two or more gases are being used the restrictor selection must be based on the air equivalent flow rate of the mixture.

Example:

The desired gas is 20% Helium (He) and 80% Chlorine (Cl) by volume.

The desired full scale flow rate of the mixture is 20 slpm.

Sensor conversion factor for the mixture is:

$$\text{Mixture Factor} = \frac{100}{\frac{20}{1.39} + \frac{80}{.83}} = .903$$

Air equivalent flow = $20/.903 = 22.15$ slpm air.

In this example a size 4 wire mesh assembly would be selected.

Table 4-4 Model 5860E Standard Restrictors

Size	Range scm Air Equivalent Flow		Part Number*		
	Low	High	Sintered	ACLFE	Wire Mesh
D	8.022	11.36	S110Z296	S110Z275	
E	11.23	15.90	S110Z297	S110Z276	
F	15.72	22.26	S110Z298	S110Z277	
G	22.01	31.17	S110Z299	S110Z278	
H	30.82	43.64	S110Z300	S110Z279	
J	43.14	61.09	S110Z301	S110Z-280	
K	60.40	85.53	S110Z302	S110Z281	
L	84.56	119.7	S110Z303	S110Z282	
M	118.4	167.6	S110Z304	S110Z283	
N	165.7	234.7	S110Z305	S110Z284	
P	232.0	328.6	S110Z306	S110Z285	
Q	324.8	460.0	S110Z307	S110Z286	
R	454.8	644.0	S110Z308	S110Z287	
S	636.7	901.6	S110Z309	S110Z288	
T	891.4	1262.	S110Z310	S110Z289	
U	1248.	1767.	S110Z311	S110Z290	
V	1747.	2474.	S110Z312	S110Z291	
W	2446.	3464.	S110Z313	S110Z292	
X	3424.	4849.			S110Z319
Y	4794.	6789.			S110Z321
1	6711.	9504.			S110Z317
2	9396.	13310.			S110Z228
3	13150.	18630.			S110Z226
4	18420.	30000.			S110Z224

*Materials: BMT = 316 Stainless Steel (ACLFE only)

BMA = Sintered 316 Stainless Steel (Wire Mesh and Sintered)

NOTE: For flow rates less than 8 sccm use the low flow plug, P/N 618K020BMT in place of a restrictor assembly.

*THIS PAGE WAS
INTENTIONALLY
LEFT BLANK*

5-1 General

When ordering parts, please specify:

Brooks Serial Number
Model Number
Part Description
Part Number
Quantity

(Refer to Figure 5-1 and Tables 5-1 and 5-2).

Brooks® Model 5860E

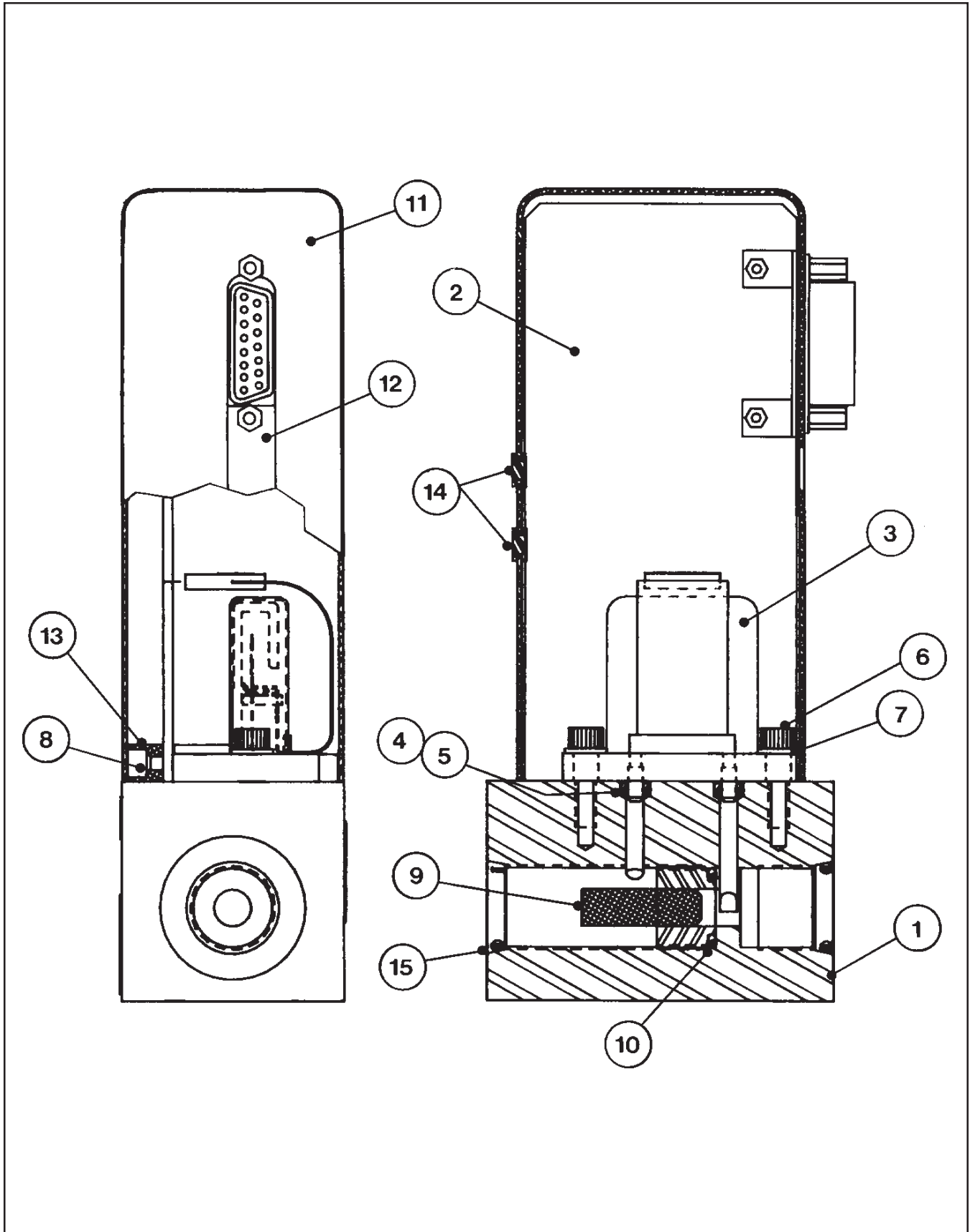

5-2 Figure 5-1 Model 5860E Parts Drawing

Table 5-1 Model 5860E Replacement Parts List

Item No.	Qty.	Description	Part Number
1	1	Flowmeter Body	092Z773BM%
2	1	PC Board Assembly (D-Connector)	S097Y847AAA
3	1	Sensor Assembly	S774Z607AAA
4	2	O-ring, Sensor, Size 004	375B004***
5	2	Backup Ring, Sensor	962A027NZA
6	2	Screw Sensor Body	751Z107AA0
7	2	Lock Washer, Sensor	926D006AWA
8	5	Screw, Sensor PC Board Cover	753L056AWZ
9	1	Restrictor Assembly and Components (Refer to Section 4-7 for sizing)	
10	1	O-ring, Restrictor, Size 109	375B109***
11	1	Electronics Cover Can (D-Connector)	219Z392EA%
12	1	Cover Plate	852Z213EA%
13	1	PC Board Mounting Bracket	079Z135EAA
14	2	Pot Hole Plug	620Z434SXA
NS	2	Fittings:	
		1/4" Compression, Swagelok	320B136BMA
		1/4" Male VCR, Cajon	315Z036BMA
		1/4" Male VCO, Cajon	315Z035BMA
15	2	O-ring, Fitting, Size 906	375B906***
NS	2	O-ring, VCO Gland, Size 010	375B010***
NS	1	Interconnecting Cables:	Length: D-type
		Connector on one end with no termination on other end	5 Feet S124Z361AAA
			10 Feet S124Z362AAA
			25 Feet S124Z363AAA
		50 Feet S124Z435AAA	
NS	1	Connector on one end with Connector for Model 5870 Series Secondary Electronics on other end	5 Feet S124Z576AAA
			10 Feet S124Z577AAA
			25 Feet S124Z578AAA
			50 Feet S124Z579AAA
NS	2	8-32 Mounting Screw	Customer Supplied

***QTA=Viton, SUA=Buna, TTA=Kalrez, AR=As Required, NS=Not Shown

Table 5-2 Tool and Spare Part Kits for Model 5860E

<p>Model 5850 Service Tool Kit P/N S778D017AAA</p> <p>Permits the complete disassembly of the Model 5850E for servicing.</p> <p>Contains:</p> <ul style="list-style-type: none"> 1 - O-ring Removal Tool 1 - Potentiometer Adjustment Tool 1 - Ball Point Allen Wrench 1 - Phillips Screw Driver 1 - Nut Driver for Orifice 1 - Restrictor Removal Tool 1 - Common Screw Driver 	<p>Model 5850 Break Out Board Assembly P/N S273Z668AAA</p> <p>Installs directly between mass flow sensor/controller and interconnecting cable. Allows convenient access to all signals for easy troubleshooting of system.</p> <ul style="list-style-type: none"> 1 - Break Out PC Board 1 - 5 foot Extension Cable 1 - Terminal PC Board
---	---

*THIS PAGE WAS
INTENTIONALLY
LEFT BLANK*

Dansk

Brooks Instrument
407 West Vine St.
Hatfield, PA 19440
U.S.A.

Emne : **Tillæg til instruktions manual.**
Reference : **CE mærkning af Masse Flow udstyr**
Dato : **Januar-1996.**

Brooks Instrument har gennemført CE mærkning af elektronisk udstyr med succes, i henhold til regulativet om elektrisk støj (EMC direktivet 89/336/EEC).

Der skal dog gøres opmærksom på benyttelsen af signalkabler i forbindelse med CE mærkede udstyr.

Kvaliteten af signal kabler og stik:

Brooks lever kabler af høj kvalitet, der imødekommer specifikationerne til CE mærkning.

Hvis der anvendes andre kabel typer skal der benyttes et skærmet kabel med hel skærm med 100% dækning. Forbindelses stikket type "D" eller "cirkulære", skal være skærmet med metalhus og eventuelle PG-forskrutninger skal enten være af metal eller metal skærmet.

Skærmen skal forbindes, i begge ender, til stikkets metalhus eller PG-forskrutningen og have forbindelse over 360 grader.

Skærmen bør være forbundet til jord.

"Card Edge" stik er standard ikke af metal, der skal derfor ligeledes benyttes et skærmet kabel med hel skærm med 100% dækning.

Skærmen bør være forbundet til jord.

Forbindelse af stikket; venligst referer til vedlagte instruktions manual.

Med venlig hilsen,

Deutsch

Brooks Instrument
407 West Vine St.
Hatfield, PA 19440
U.S.A.

Subject : **Nachtrag zur Bedienungsanleitung.**
Referenz : **CE Zertifizierung für Massedurchflußgeräte**
Datum : **Januar-1996.**

Nach erfolgreichen Tests entsprechend den Vorschriften der Elektromagnetischen Verträglichkeit (EMC Richtlinie 89/336/EEC) erhalten die Brooks-Geräte (elektrische/elektronische Komponenten) das CE-Zeichen.

Bei der Auswahl der Verbindungskabel für CE-zertifizierte Geräte sind spezielle Anforderungen zu beachten.

Qualität der Verbindungskabel, Anschlußstecker und der Kabeldurchführungen

Die hochwertigen Qualitätskabel von Brooks entsprechen der Spezifikation der CE-Zertifizierung.

Bei Verwendung eigener Verbindungskabel sollten Sie darauf achten, daß eine 100 %igen Schirmabdeckung des Kabels gewährleistet ist.

"D" oder "Rund" -Verbindungsstecker sollten eine Abschirmung aus Metall besitzen.

Wenn möglich, sollten Kabeldurchführungen mit Anschlußmöglichkeiten für die Kabelabschirmung verwendet werden.

Die Abschirmung des Kabels ist auf beiden Seiten des Steckers oder der Kabeldurchführungen über den vollen Umfang von 360 ° anzuschließen.

Die Abschirmung ist mit dem Erdpotential zu verbinden.

Platinen-Steckverbindungen sind standardmäßige keine metallgeschirmten Verbindungen. Um die Anforderungen der CE-Zertifizierung zu erfüllen, sind Kabel mit einer 100 %igen Schirmabdeckung zu verwenden.

Die Abschirmung ist mit dem Erdpotential zu verbinden.

Die Belegung der Anschlußpins können Sie dem beigelegten Bedienungshandbuch entnehmen.

Brooks® Model 5860E

English

Brooks Instrument

407 West Vine St.

Hatfield, PA 19440

U.S.A.

Subject : Addendum to the Instruction Manual.**Reference : CE certification of Mass Flow Equipment****Date : January-1996.**

The Brooks (electric/electronic) equipment bearing the CE mark has been successfully tested to the regulations of the Electro Magnetic Compatibility (EMC directive 89/336/EEC).

Special attention however is required when selecting the signal cable to be used with CE marked equipment.

Quality of the signal cable, cable glands and connectors:

Brooks supplies high quality cable(s) which meets the specifications for CE certification.

If you provide your own signal cable you should use a cable which is overall completely screened with a 100% shield.

“D” or “Circular” type connectors used should be shielded with a metal shield. If applicable, metal cable glands must be used providing cable screen clamping.

The cable screen should be connected to the metal shell or gland and shielded at both ends over 360 Degrees.

The shield should be terminated to a earth ground.

Card Edge Connectors are standard non-metallic. The cables used must be screened with 100% shield to comply with CE certification.

The shield should be terminated to a earth ground.

For pin configuration : Please refer to the enclosed Instruction Manual.

Español

Brooks Instrument

407 West Vine St.

Hatfield, PA 19440

U.S.A.

Asunto : Addendum al Manual de Instrucciones.**Referencia : Certificación CE de los Equipos de Caudal Másico****Fecha : Enero-1996.**

Los equipos de Brooks (eléctricos/electrónicos) en relación con la marca CE han pasado satisfactoriamente las pruebas referentes a las regulaciones de Compatibilidad Electro magnética (EMC directiva 89/336/EEC).

Sin embargo se requiere una atención especial en el momento de seleccionar el cable de señal cuando se va a utilizar un equipo con marca CE

Calidad del cable de señal, prensaestopas y conectores:

Brooks suministra cable(s) de alta calidad, que cumple las especificaciones de la certificación CE .

Si usted adquiere su propio cable de señal, debería usar un cable que esté completamente protegido en su conjunto con un apantallamiento del 100%.

Cuando utilice conectores del tipo “D” ó “Circular” deberían estar protegidos con una pantalla metálica. Cuando sea posible, se deberán utilizar prensaestopas metálicos provistos de abrazadera para la pantalla del cable.

La pantalla del cable deberá ser conectada al casquillo metálico ó prensa y protegida en ambos extremos completamente en los 360 Grados.

La pantalla deberá conectarse a tierra.

Los conectores estandar de tipo tarjeta (Card Edge) no son metálicos, los cables utilizados deberán ser protegidos con un apantallamiento del 100% para cumplir con la certificación CE.

La pantalla deberá conectarse a tierra.

Para ver la configuración de los pines: Por favor, consultar Manual de Instrucciones adjunto.

Français

Brooks Instrument
407 West Vine St.
Hatfield, PA 19440
U.S.A.

Sujet : **Annexe au Manuel d'Instructions.**
Référence : **Certification CE des Débitmètres Massiques à Effet Thermique.**
Date : **Janvier 1996.**

Messieurs,

Les équipements Brooks (électriques/électroniques) portant le label CE ont été testés avec succès selon les règles de la Compatibilité Electromagnétique (directive CEM 89/336/EEC).

Cependant, la plus grande attention doit être apportée en ce qui concerne la sélection du câble utilisé pour véhiculer le signal d'un appareil portant le label CE.

Qualité du câble, des presse-étoupes et des connecteurs:

Brooks fournit des câbles de haute qualité répondant aux spécifications de la certification CE.

Si vous approvisionnez vous-même ce câble, vous devez utiliser un câble blindé à 100 %.

Les connecteurs « D » ou de type « circulaire » doivent être reliés à la terre.

Si des presse-étoupes sont nécessaires, ceux ci doivent être métalliques avec mise à la terre.

Le blindage doit être raccordé aux connecteurs métalliques ou aux presse-étoupes sur le pourtour complet du câble, et à chacune de ses extrémités.

Tous les blindages doivent être reliés à la terre.

Les connecteurs de type « card edge » sont non métalliques. Les câbles utilisés doivent être blindés à 100% pour satisfaire à la réglementation CE.

Tous les blindages doivent être reliés à la terre.

Se référer au manuel d'instruction pour le raccordement des contacts.

Greek

Brooks Instrument
407 West Vine St.
Hatfield, PA 19440
U.S.A.

Θέμα : **Προσθήκη στο Εγχειρίδιο Οδηγιών.**
Σχετικά : **Πιστοποίηση CE των Οργάνων Μέτρησης Παροχής Μάζας.**
Ημερομηνία : **Ιανουάριος - 1996**

Κυρίες και Κύριοι,

Τα όργανα (ηλεκτρικά/ηλεκτρονικά) της Brooks τα οποία φέρουν το σήμα CE έχουν επιτυχώς ελεγχθεί σύμφωνα με τους κανονισμούς της Ηλεκτρο-Μαγνητικής Συμβατότητας (EMC ντυρεκτιβα 89/336/EEC).

Οποσδήποτε χρειάζεται ειδική προσοχή κατά την επιλογή του καλωδίου μεταφοράς του σήματος το οποίο (καλώδιο) πρόκειται να χρησιμοποιηθεί με όργανα που φέρουν το σήμα CE.

Ποιότητα του καλωδίου σήματος των συσπλοθλιπτόν και των συνδέσμων.

Η Brooks κατά κανόνα προμηθεύει υψηλής ποιότητας καλώδια τα οποία πληρούν τις προδιαγραφές για πιστοποίηση CE.

Εάν η επιλογή του καλωδίου σήματος γίνει από σας πρέπει να χρησιμοποιήσετε καλώδιο το οποίο να φέρει εξωτερικά πλήρες πλέγμα και να παρέχει θωράκιση 100%.

Οι σύνδεσμοι τύπου "D" ή "Κυκλικοί" των καλωδίων, πρέπει να θωρακίζονται με μεταλλική θωράκιση. Εάν είναι εφαρμόσιμο, πρέπει να χρησιμοποιούνται μεταλλικοί συσπλοθλιπτες καλωδίων που να διαθέτουν ακροδέκτη σύνδεσης του πλέγματος του καλωδίου.

Το πλέγμα του καλωδίου πρέπει να συνδέεται στο μεταλλικό περιβλήμα ή στον συσπλοθλιπτη και να θωρακίζεται και στα δύο άκρα κατά 360 μοίρες.

Η θωράκιση πρέπει να καταλήγει σε κάποιο ακροδέκτη γείωσης.

Οι σύνδεσμοι καρτών είναι μη-μεταλλικοί, τα καλώδια που χρησιμοποιούνται πρέπει να φέρουν πλέγμα θωράκισης 100% για να υπακούουν στην πιστοποίηση CE. Η θωράκιση πρέπει να καταλήγει σε κάποιο ακροδέκτη γείωσης.

Για την διάταξη των ακροδεκτών: Παρακαλούμε αναφερθείτε στο εσώκλειστο Εγχειρίδιο Οδηγιών.

Brooks® Model 5860E

Italiano

Brooks Instrument
407 West Vine St.
Hatfield, PA 19440
U.S.A.

Oggetto : **Addendum al manuale di istruzioni.**
Riferimento : **Certificazione CE dei misuratori termici di portata in massa**
Data : **Gennaio 1996.**

Questa strumentazione (elettrica ed elettronica) prodotta da Brooks Instrument, soggetta a marcatura CE, ha superato con successo le prove richieste dalla direttiva per la Compatibilità Elettromagnetica (Direttiva EMC 89/336/EEC).

E' richiesta comunque una speciale attenzione nella scelta dei cavi di segnale da usarsi con la strumentazione soggetta a marchio CE.

Qualità dei cavi di segnale e dei relativi connettori:

Brooks fornisce cavi di elevata qualità che soddisfano le specifiche richieste dalla certificazione CE. Se l'utente intende usare propri cavi, questi devono possedere una schermatura del 100%.

I connettori sia di tipo "D" che circolari devono possedere un guscio metallico. Se esiste un passacavo esso deve essere metallico e fornito di fissaggio per lo schermo del cavo.

Lo schermo del cavo deve essere collegato al guscio metallico in modo da schermarlo a 360° e questo vale per entrambe le estremità.

Lo schermo deve essere collegato ad un terminale di terra.

I connettori "Card Edge" sono normalmente non metallici. Il cavo impiegato deve comunque avere una schermatura del 100% per soddisfare la certificazione CE.

Lo schermo deve essere collegato ad un terminale di terra.

Per il corretto cablaggio dei terminali occorre fare riferimento agli schemi del manuale di istruzioni dello strumento.

Nederlands

Brooks Instrument
407 West Vine St.
Hatfield, PA 19440
U.S.A.

Onderwerp : **Addendum voor Instructie Handboek**
Referentie : **CE certificering voor Mass Flow Meters & Controllers**
Datum : **Januari 1996**

Dames en heren,

Alle CE gemarkeerde elektrische en elektronische producten van Brooks Instrument zijn met succes getest en voldoen aan de wetgeving voor Electro Magnetische Compatibiliteit (EMC wetgeving volgens 89/336/EEC).

Speciale aandacht is echter vereist wanneer de signaalkabel gekozen wordt voor gebruik met CE gemarkeerde producten.

Kwaliteit van de signaalkabel en kabelaansluitingen:

- Brooks levert standaard kabels met een hoge kwaliteit, welke voldoen aan de specificaties voor CE certificering.
Indien men voorziet in een eigen signaalkabel, moet er gebruik gemaakt worden van een kabel die volledig is afgeschermd met een bedekkingsgraad van 100%.
- "D" of "ronde" kabelconnectoren moeten afgeschermd zijn met een metalen connector kap. Indien kabelwartels worden toegepast, moeten metalen kabelwartels worden gebruikt die het mogelijk maken het kabelscherm in te klemmen.
Het kabelscherm moet aan beide zijden over 360° met de metalen connectorkap, of wartel verbonden worden. Het scherm moet worden verbonden met aarde.
- "Card-edge" connectors zijn standaard niet-metallisch. De gebruikte kabels moeten volledig afgeschermd zijn met een bedekkingsgraad van 100% om te voldoen aan de CE certificering.
Het scherm moet worden verbonden met aarde.

Norsk

Brooks Instrument
407 West Vine St.
Hatfield, PA 19440
U.S.A.

Vedrørende : Vedlegg til håndbok
Referanse : CE sertifisering av utstyr for massestrømsmåling og regulering
Dato : Januar 1996

Til den det angår

Brooks Instrument elektrisk og elektronisk utstyr påført CE-merket har gjennomgått og bestått prøver som beskrevet i EMC forskrift om elektromagnetisk immunitet, direktiv 89/336/EEC.

For å opprettholde denne klassifisering er det av stor viktighet at riktig kabel velges for tilkobling av det måletekniske utstyret.

Utførelse av signalkabel og tilhørende plugger:

- Brooks Instrument tilbyr levert med utstyret egnet kabel som møter de krav som stilles til CE-sertifisering.
 - Dersom kunden selv velger kabel, må kabel med fullstendig, 100% skjerming av lederene benyttes. "D" type og runde plugger og forbindelser må være utført med kappe i metall og kabelnipler må være utført i metall for jordet innfesting av skjermen. Skjermen i kablen må tilknyttes metallet i pluggen eller nippelen i begge ender over 360°, tilkoblet elektrisk jord.
 - Kort-kantkontakter er normalt utført i kunststoff. De tilhørende flatkabler må være utført med fullstendig, 100% skjerming som kobles til elektrisk jord på riktig pinne i pluggen, for å møte CE sertifiseringskrav. For tilkobling av medleverte plugger, vennligst se håndboken som hører til utstyret.
- Vennlig hilsen

Português

Brooks Instrument
407 West Vine St.
Hatfield, PA 19440
U.S.A.

Assunto : Adenda ao Manual de Instruções
Referência : Certificação CE do Equipamento de Fluxo de Massa
Data : Janeiro de 1996.

O equipamento (eléctrico/electrónico) Brooks com a marca CE foi testado com êxito nos termos do regulamento da Compatibilidade Electromagnética (directiva CEM 89/336/EEC).

Todavia, ao seleccionar-se o cabo de sinal a utilizar com equipamento contendo a marca CE, será necessário ter uma atenção especial.

Qualidade do cabo de sinal, buchas de cabo e conectores:

A Brooks fornece cabo(s) de qualidade superior que cumprem os requisitos da certificação CE.

Se fornecerem o vosso próprio cabo de sinal, devem utilizar um cabo que, na sua totalidade, seja isolado com uma blindagem de 100%.

Os conectores tipo "D" ou "Circulares" devem ser blindados com uma blindagem metálica. Se tal for necessário, deve utilizar-se buchas metálicas de cabo para o isolamento do aperto do cabo.

O isolamento do cabo deve ser ligado à blindagem ou bucha metálica em ambas as extremidades em 360°.

A blindagem deve terminar com a ligação à massa.

Os conectores "Card Edge" não são, em geral, metálicos e os cabos utilizados devem ter um isolamento com blindagem a 100% nos termos da Certificação CE..

A blindagem deve terminar com ligação à massa.

Relativamente à configuração da cavilha, queiram consultar o Manual de Instruções.

Brooks® Model 5860E

Suomi

Brooks Instrument
407 West Vine St.
Hatfield, PA 19440
U.S.A.

Asia : Lisäys Käyttöohjeisiin
Viite : Massamäärämittareiden CE sertifiointi
Päivämäärä : Tammikuu 1996

Brooksin CE merkillä varustetut sähköiset laitteet ovat läpäissyt EMC testit (direktiivi 89/336/EEC). Erityistä huomiota on kuitenkin kiinnitettävä signaalikaapelin valintaan.

Signaalikaapelin, kaapelin läpiviennin ja liittimen laatu

Brooks toimittaa korkealaatuisia kaapeleita, jotka täyttävät CE sertifiointivaatimukset. Hankkiessaan signaalikaapelin itse, olisi hankittava 100%:sti suojattu kaapeli.

“D” tai “Circular” tyyppisen liittimen tulisi olla varustettu metallisuojuksella. Mikäli mahdollista, tulisi käyttää metallisia kaapeliliittimiä kiinnitettäessä suoja.

Kaapelin suoja tulisi olla liitetty metallisuojaan tai liitimeen molemmissa päissä 360°:n matkalta.

Suojan tulisi olla maadoitettu.

“Card Edge Connector”it ovat standarditoimituksina ei-metallisia. Kaapeleiden täytyy olla 100%: sesti suojattuja jotta ne olisivat CE sertifiointivaatimusten mukaisia.

Suoja on oltava maadoitettu.

Nastojen liittäminen; katso liitteenä oleva manuaali.

Ystävällisin terveisin,

Svensk

Brooks Instrument
407 West Vine St.
Hatfield, PA 19440
U.S.A.

Subject : Addendum to the Instruction Manual
Reference : CE certification of Mass Flow Equipment
Date : January 1996

Brooks (elektriska / elektronik) utrustning, som är CE-märkt, har testats och godkänts enligt gällande regler för elektromagnetisk kompatibilitet (EMC direktiv 89/336/EEC).

Speciell hänsyn måste emellertid tas vid val av signalkabel som ska användas tillsammans med CE-märkt utrustning.

Kvalitet på signalkabel och anslutningskontakter:

Brooks levererar som standard, kablar av hög kvalitet som motsvarar de krav som ställs för CE-godkännande. Om man använder en annan signalkabel ska kabeln i sin helhet vara skärmad till 100%.

“D” eller “runda” typer av anslutningskontakter ska vara skärmade. Kabelgenomföringar ska vara av metall alternativt med metalliserad skärmning.

Kabelns skärm ska, i bada ändar, vara ansluten till kontakternas metallkåpor eller genomföringar med 360 graders skärmning.

Skärmen ska avslutas med en jordförbindelse.

Kortkontakter är som standard ej metalliserade, kablar som används måste vara 100% skärmade för att överensstämja med CE-certifieringen.

Skärmen ska avslutas med en jordförbindelse.

För elektrisk anslutning till kontaktstiften hänvisas till medföljande instruktionsmanual.

Installation and Operation Manual

X-TMF-5860E-MFM-eng

Part Number: 541B106AAG

November, 2008

Brooks® Model 5860E

*THIS PAGE WAS
INTENTIONALLY
LEFT BLANK*

Brooks® Model 5860E

LIMITED WARRANTY

Seller warrants that the Goods manufactured by Seller will be free from defects in materials or workmanship under normal use and service and that the Software will execute the programming instructions provided by Seller until the expiration of the earlier of twelve (12) months from the date of initial installation or eighteen (18) months from the date of shipment by Seller. Products purchased by Seller from a third party for resale to Buyer ("Resale Products") shall carry only the warranty extended by the original manufacturer.

All replacements or repairs necessitated by inadequate preventive maintenance, or by normal wear and usage, or by fault of Buyer, or by unsuitable power sources or by attack or deterioration under unsuitable environmental conditions, or by abuse, accident, alteration, misuse, improper installation, modification, repair, storage or handling, or any other cause not the fault of Seller are not covered by this limited warranty, and shall be at Buyer's expense.

Goods repaired and parts replaced during the warranty period shall be in warranty for the remainder of the original warranty period or ninety (90) days, whichever is longer. This limited warranty is the only warranty made by Seller and can be amended only in a writing signed by an authorized representative of Seller.

BROOKS SERVICE AND SUPPORT

Brooks is committed to assuring all of our customers receive the ideal flow solution for their application, along with outstanding service and support to back it up. We operate first class repair facilities located around the world to provide rapid response and support. Each location utilizes primary standard calibration equipment to ensure accuracy and reliability for repairs and recalibration and is certified by our local Weights and Measures Authorities and traceable to the relevant International Standards.

Visit www.BrooksInstrument.com to locate the service location nearest to you.

START-UP SERVICE AND IN-SITU CALIBRATION

Brooks Instrument can provide start-up service prior to operation when required.

For some process applications, where ISO-9001 Quality Certification is important, it is mandatory to verify and/or (re)calibrate the products periodically. In many cases this service can be provided under in-situ conditions, and the results will be traceable to the relevant international quality standards.

CUSTOMER SEMINARS AND TRAINING

Brooks Instrument can provide customer seminars and dedicated training to engineers, end users and maintenance persons.

Please contact your nearest sales representative for more details.

HELP DESK

In case you need technical assistance:

- Americas ☎ 1-888-554-FLOW
- Europe ☎ +(31) 318 549 290 Within Netherlands ☎ 0318 549 290
- Asia ☎ +011-81-3-5633-7100

Due to Brooks Instrument's commitment to continuous improvement of our products, all specifications are subject to change without notice.

TRADEMARKS

- Brooks Brooks Instrument, LLC
- Freon TF E. I. DuPont deNemours & Co.
- Kalrez DuPont Dow Elastomers
- NRS Brooks Instrument, LLC
- VCO Cajon Company
- VCR Cajon Company
- Viton DuPont Performance Elastomers



Brooks Instrument
 407 West Vine Street
 P.O. Box 903
 Hatfield, PA 19440-0903 USA
 T (215) 362-3700
 F (215) 362-3745
 E-Mail BrooksAm@BrooksInstrument.com
www.BrooksInstrument.com

Brooks Instrument
 Neonstraat 3
 6718 WX Ede, Netherlands
 T 31-318-549-300
 F 31-318-549-309
 E-Mail BrooksEu@BrooksInstrument.com

Brooks Instrument
 1-4-4 Kitasuna Koto-Ku
 Tokyo, 136-0073 Japan
 T 011-81-3-5633-7100
 F 011-81-3-5633-7101
 E-Mail BrooksAs@BrooksInstrument.com

