

# SS2 Series

Pressure Transducers

User Guide

Celerity, Inc.  
915 Enterprise Boulevard  
Allen, TX 75013 USA  
T +1 972 359 4000  
F +1 972 359 4100

A333382001 REV. 002 8/07



<b>_1.0 PRODUCT DESCRIPTION AND SPECIFICATIONS</b>	<b>1</b>
_1.1 INTRODUCTION	1
_1.2 INTENDED USE	1
_1.3 NOTICE AND CAUTION STATEMENTS	1
_1.4 PRODUCT DESCRIPTION CODE	2
_1.5 SS2 PRESSURE TRANSDUCER SPECIFICATIONS	3
_1.6 STANDARD SS2 PRESSURE TRANSDUCERS DIMENSIONAL DRAWINGS	4
_1.7 SS2 ATEX PRESSURE TRANSDUCERS DIMENSIONAL DRAWINGS	5
<b>_2.0 INSTALLATION</b>	<b>6</b>
_2.1 MECHANICAL INSTALLATION	6
_2.2 ELECTRICAL WIRING	7
_2.3 ZERO ADJUSTMENT	10
<b>_3.0 PRODUCT WARRANTY</b>	<b>12</b>

## 1.1 INTRODUCTION

This user guide covers Celerity SS2 Series Pressure Transducers as shown in Figure 1. Included herein is a product description, operating specifications, installation details, and product warranty information.



Figure 1. Celerity SS2 Pressure Transducers

## 1.2 INTENDED USE

Celerity SS2 pressure transducers are the ultimate in high purity and accuracy for pressure monitoring. The SS2 series meets the most rigid semiconductor high purity specifications. With accuracy of better than 0.25% of full scale, SS2 pressure transducers are used to provide years of reliable pressure monitoring for most semiconductor applications. The SS2 series pressure transducers have one of the smallest footprints in the industry for quick and easy installation in the tightest areas.

## 1.3 NOTICE AND CAUTION STATEMENTS

NOTICE and CAUTION statements are located throughout this user guide on the left side of the page. A NOTICE statement describes information that requires special attention. The CAUTION statement describes a condition where the operator must use caution to avoid damaging the product.

### 1.4 PRODUCT DESCRIPTION CODE

The following Product Description Code (PDC) identifies the SS2 Pressure Transducer in various configurations. This code is used to order your SS2 Pressure Transducer. Call your Celerity Customer Representative if you need assistance.

XX	X	XX	X	X	X	XX	X	
GF	Gas Flow							
	Body Type	D = Dead End F = Flow Through						
		PSI	00 = 30 01 = 100 02 = 250 10 = 1000 30 = 3000					
			Pressure References	A = Absolute C = Compound D = Gauge				
				Outputs	3 = 0.00 - 10.00 V 4 = 4 to 20 mA 5 = 0.05 - 5.05 V			
					Electrical Connections	B = Bendix Connector P = 6 ft. (2 m) Pigtail D = 15 pin D-Sub HD Male Connector		
						Fittings	Single End Types: SM = Face Seal Swivel Male SF = Face Seal Swivel Female CS = 1-1/8" C-Seal WS = W-Seal Flow Through Type: 4T = 1/4" Tube Stub "T"	
							Options	A = ATEX Housing

Ordering Example:

GF	D	02	D	4	B	SM	A
----	---	----	---	---	---	----	---

### 1.5 SS2 PRESSURE TRANSDUCER SPECIFICATIONS

Category	Operating Guidelines
<b>Electrical</b>	
Supply Current	Max 10 mA for 0.00 Vdc and 0.05 to 5.05 Vdc output
Power Requirement	10 to 30 Vdc for 4 to 20 mA output 11 to 30 Vdc for 0.05 to 5.05 output 13 to 32 Vdc for 0.00 to 10.00 Vdc output
Connections	4-pin male Bendix® connector 6 ft (2m) pigtail (24 AWG shielded cable) 15-pin D Sub HD male connection
Protection	Reverse polarity for power connections
<b>Mechanical</b>	
Housing	Stainless steel, polymer plastics
Proof Pressure	200% of full scale (F.S.) up to 1000 PSI 150% of F.S. for higher ranges
Burst Pressure	400% of F.S.
Wetted Parts	316L Stainless Steel, SEMI F20
Surface Finish	Compliant to SEMI F19, 5 Ra standard
Cleanliness	Compliant to ASTM F1374-92 (2005)
Internal Volume	1.79 cc
Process connections	Refer to PDC (paragraph 1.2) for options
Shipping Weight (approximate)	0.70 lbs. (0.32 kg)
<b>Performance</b>	
Accuracy	±0.25% BFSL (Linearity, Hysteresis and Repeatability)
Response Time	< 5 msec
Thermal Zero and Span Shift (each)	≥ 100 PSI Range F.S. ±0.02% F.S/°F (-4° to 140°F, -20° to 60°C) ±0.5 F.S. (20° to 60°C) 0-10 Vdc version < 100 PSI Range F.S. ±0.04% F.S/°F (-4° to 140°F, -20° to 60°C) ±1.0 F.S. (20° to 60°C) 0-10 Vdc version
Temperature	Storage: -20° to 180°F (-29° to 82°C) Compensated: -4° to 140°F (-20° to 60°C) Compensated: 20° to 140°F (20° to 60°C) for 0-10 Vdc version
<b>Certifications</b>	
FM Approved	Non-incentive for use in Class 1, Div. 2, Groups A, B, C and D Excludes 0-10 Vdc and 15-pin D Sub HD male connection
CE	Compliant to EMC directive EN61326
RoHS*	Compliant to EU directive 2002/95/EC
ATEX*	Complaint to EU directive 94/9/EC

\*SS2 ATEX Pressure Transducer only

### 1.6 STANDARD SS2 PRESSURE TRANSDUCERS DIMENSIONAL DRAWINGS

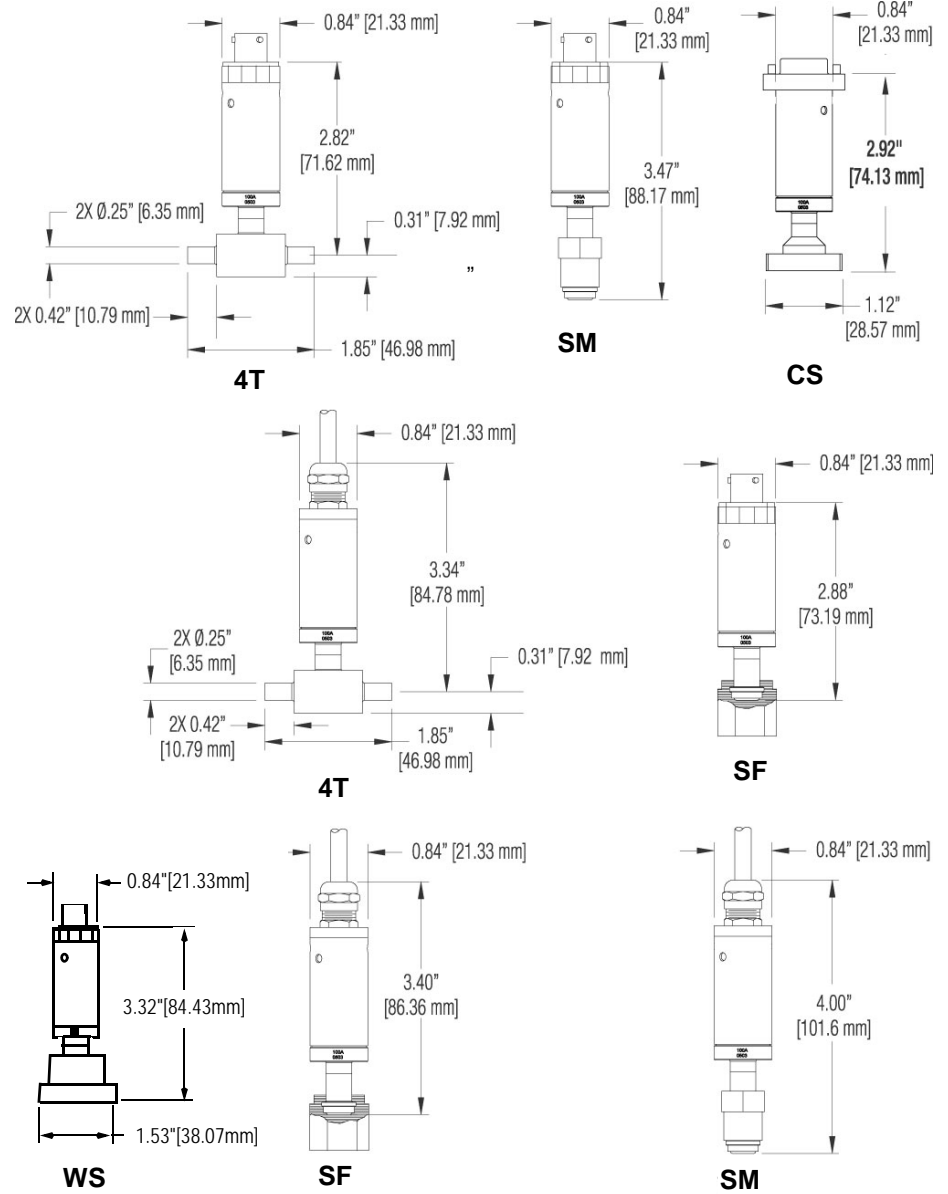

\*All face seal process connections are compatible with VCR® fittings

### 1.7 SS2 ATEX PRESSURE TRANSDUCERS DIMENSIONAL DRAWINGS

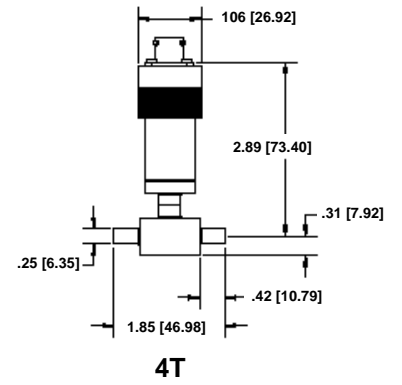
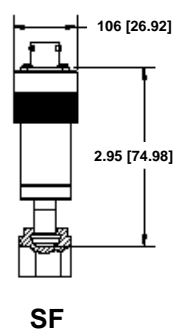
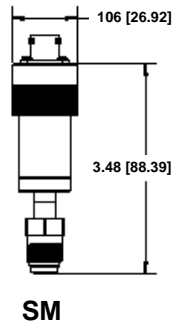
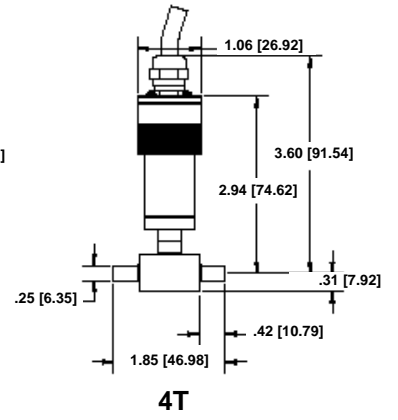
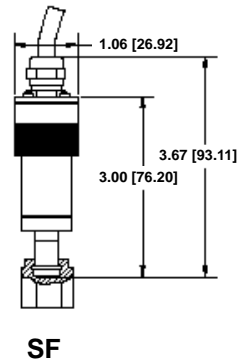
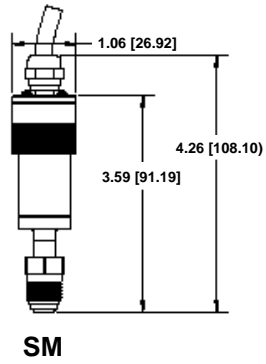

## 2.1 MECHANICAL INSTALLATION

**CAUTION** 

*Perform all operations with standard gas handling procedures in accordance with all local codes for safety and ventilation. You **MUST** wear appropriate clothing and safety apparatus for the gas you are using.*

The failure to follow these procedures may adversely affect the product's performance and could void the product warranty. Inspect, but **DO NOT** unwrap any parts until installation. Contact your Celerity representative with any problems.

### 1. Unpack the SS2 Pressure Transducer.

The SS2 Pressure Transducer is double-bagged for cleanroom service and should remain packaged until installation. **DO NOT** remove the pressure transducer from the protective bag unless you are in a clean environment.

- a. Remove the pressure transducer from the box and carry it into the gray area.
- b. Remove the outer protective bag and discard.
- c. Carry the pressure transducer (sealed in the inner bag), into the clean area.

**CAUTION** **HANDLE CAREFULLY!**

*This SS2 Pressure Transducer is a precision instrument and works by measuring stress. Therefore, the less stress placed on the SS2 Pressure Transducer during installation and handling, the greater its accuracy and life span will be.*

### 2. Install the SS2 Pressure Transducer.

- a. Prepare the connection fitting in place on the gas line. Any other fitting components, such as stainless steel gaskets, should be blown clean with filtered gas before use.
- b. Maintain a flow of at least 1 slpm (0.05 scfm) of inert gas during installation to minimize tubing and pressure transducer contamination from environmental moisture and particles. The recommended purge gas is electronic-grade Nitrogen.
- c. Open the inner bag and remove the pressure transducer. Remove any fitting protection caps and seat the pressure transducer on the mating connections.
- d. For connections compatible with VCR<sup>®</sup> fittings: Tighten by hand. Then turn the fitting 1/8 turn past finger-tight using a wrench.

**CAUTION** 

***DO NOT** overtighten fittings. Refer to specific technical guide-*



lines that are supplied through the fitting manufacturer.

3. Prepare the SS2 Pressure Transducer for Use.
  - a. Verify integrity of the seal by appropriate helium leak-testing procedures.
  - b. Turn the gas flow ON then OFF, 10 times to remove any particles generated during installation. (The flow rate used should at least equal the process flow specifications.)
  - c. Mechanical Installation is complete. Complete the electrical wiring connections as noted in the next section.

## 2.2 ELECTRICAL WIRING

Electrical Wiring diagrams are shown in Figures 2 through 8. Connect the cable braid and drain wire to an earth ground to help reduce inductive signal interference.

**NOTICE**  
 Grounding of the cable braid and drain wire are necessary in order to comply with CE immunity requirements. A shielded cable is permanently connected to the SS2 Pressure Transducer.

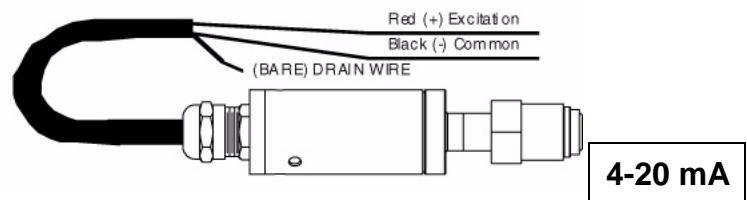

Figure 2. 4-20 mA Pigtail Cable Wiring

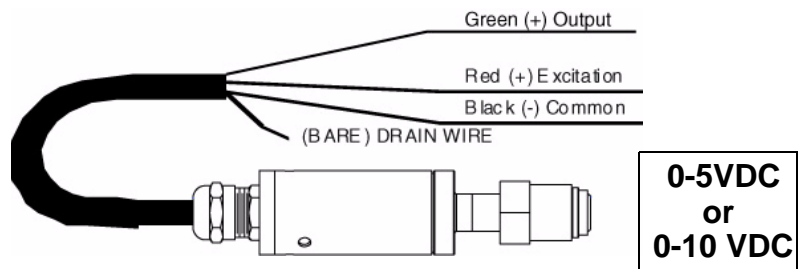

Figure 3. 0-5 Vdc or 0-10 Vdc Pigtail Cable Wiring

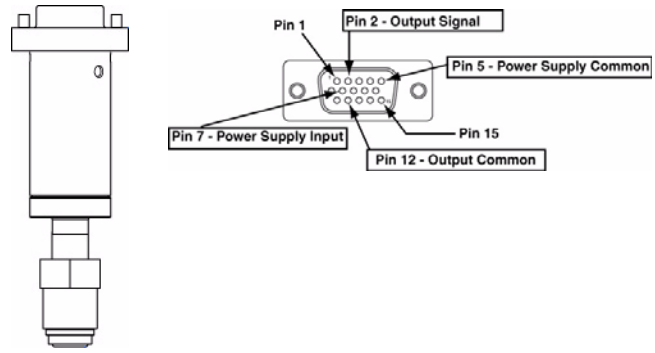

Figure 4. 15 Pin D Sub HD Connector Wiring Pinout

The Bendix™ connector cable has a removable, four-pin locking connector with a shielded cable. The connector is available from Celerity under part number EL3000032010.

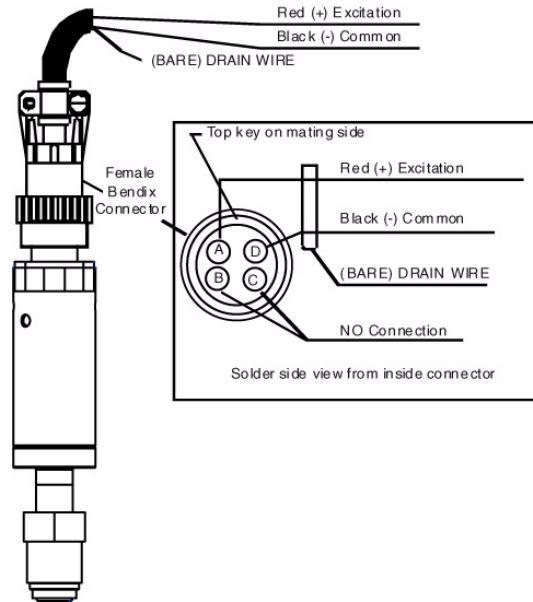

Figure 5. 4-20 mA Bendix™ Cable Wiring

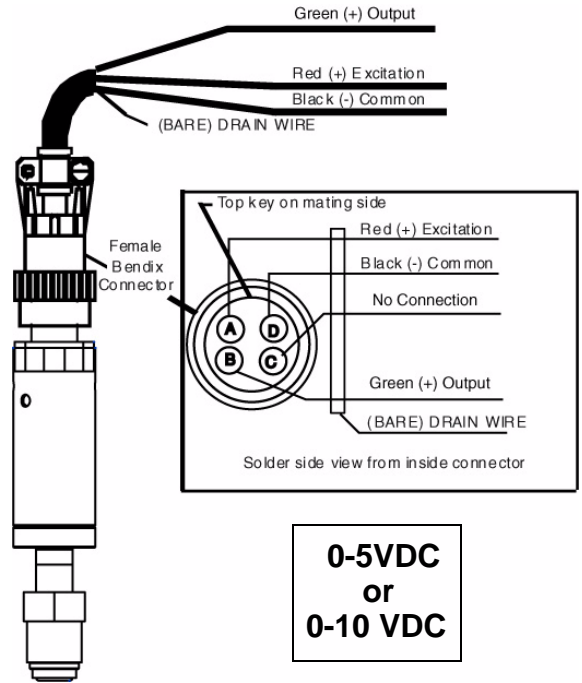

Figure 6. 0-5 Vdc or 0-10 Vdc Bendix™ Cable Wiring

The SS2 Pressure Transducer can be wired directly to a 12 or 24 Vdc LR250. Both pigtail and Bendix™ cables are connected as shown in Figure 7 and 8

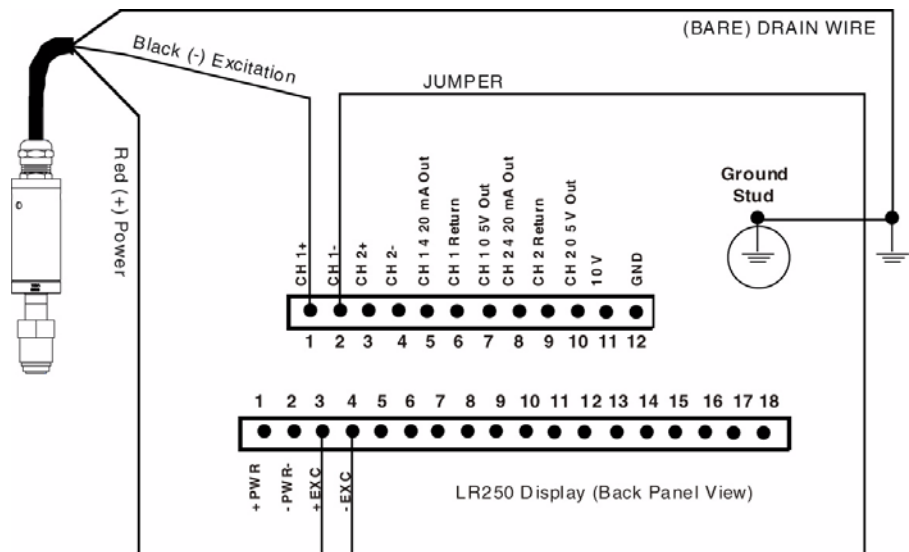

Figure 7. 4-20 mA Output Device Wiring to LR250

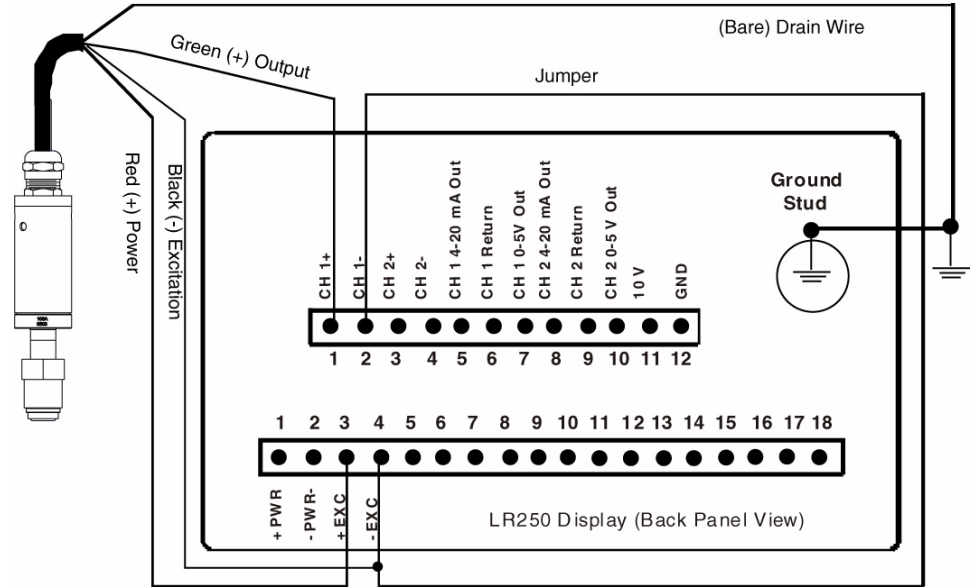

Figure 8. 0-5 Vdc Output Device Wiring to LR250

### 2.3 ZERO ADJUSTMENT

The SS2 Pressure Transducer is factory calibrated and does not normally need a field adjustment. If a field adjustment becomes necessary, adjust the zero as noted below.

#### 2.3.1 Zero Adjustment (Standard Pressure Transducers)

On standard SS2 Pressure Transducer models, the zero adjustment screw is located on the body as shown in Figure 9.

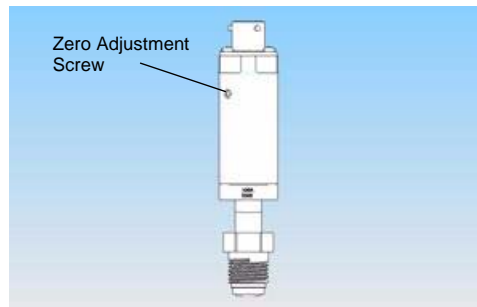

Figure 9. Zero Adjustment Screw (Standard SS2 Pressure Transducers)

Position the SS2 Pressure Transducer with the electrical connector pointing upward. Using a small, flat-bladed screw driver, turn the zero adjustment screw in a clockwise direction to increase the signal. Turn the screw in a counterclockwise direction to decrease the signal.

### 2.3.2 Zero Adjustment (ATEX SS2 pressure transducers only)

On ATEX SS2 Pressure Transducers, the zero adjustment screw is located underneath the access cover as shown in Figure 10A. Unscrew the access cover by turning it in counterclockwise direction with the electrical connector pointing upward. The cover should drop down after five, complete revolutions.

The zero adjustment screw is shown in Figure 10B. Using a small, flat-bladed screw driver, turn the zero adjustment screw in a clockwise direction to increase the signal, or turn it in a counterclockwise direction to decrease the signal. Screw the cover back on when completed.

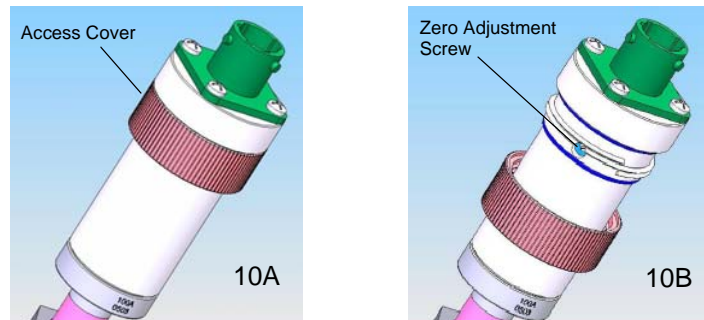

Figure 10. Zero Adjustment (ATEX SS2 pressure transducer)

Product warranty information can be found on our Celerity website at [www.Celerity.net](http://www.Celerity.net). This information provides general warranty information, limitations, disclaimers, and applicable warranty periods according to product group.



CELERITY, INC.  
915 Enterprise Boulevard  
Allen, TX 75013 USA  
Telephone 972.359.4000  
Facsimile 972.359.4100  
[www.celerity.net](http://www.celerity.net)



For technical assistance, contact Celerity Technical Support at 972.359.4000.

Celerity is a trademark of Celerity, Inc. All other product or service names mentioned in this document may be trademarks of the companies with which they are associated. System descriptions are typical and subject to change without notice.

©2007 Celerity, Inc.

A333382001 Rev 002

8/07