

Data Sheet

DS-LP-MR783-MLS-eng

November, 2009

Type MR783 Magnetic Level Switches

Models MR7831, MR783 PVC, MR783 PVDF

Features and Benefits

- Compact size - easy to mount in multiple locations on the tank
- Versatile construction - 316SS, PVC or PVDF compatible with many fluids
- Certified explosion-proof or intrinsically safe

Description

The float unit can be directly mounted on a tank through a screwed or flanged connection. A second application is available as a magnetic switch indicator while fitted on the side of a magnetic level gauge for example.

The internal float of the gauge will directly activate the contacts into the tube.

This flow switch consists of:

- A guide tube fitted with one or more magnetic contacts positioned as required
- One float fitted with a magnet
- Connection: screwed plug or flange
- A sealed electric junction box complete with strip and cable gland.

Materials of Construction

All Wetted parts

(guide tube, float, screwed connectors or flange):

MR783 1: stainless steel 316L

MR783 PVC: PVC

MR783 PVDF: PVDF

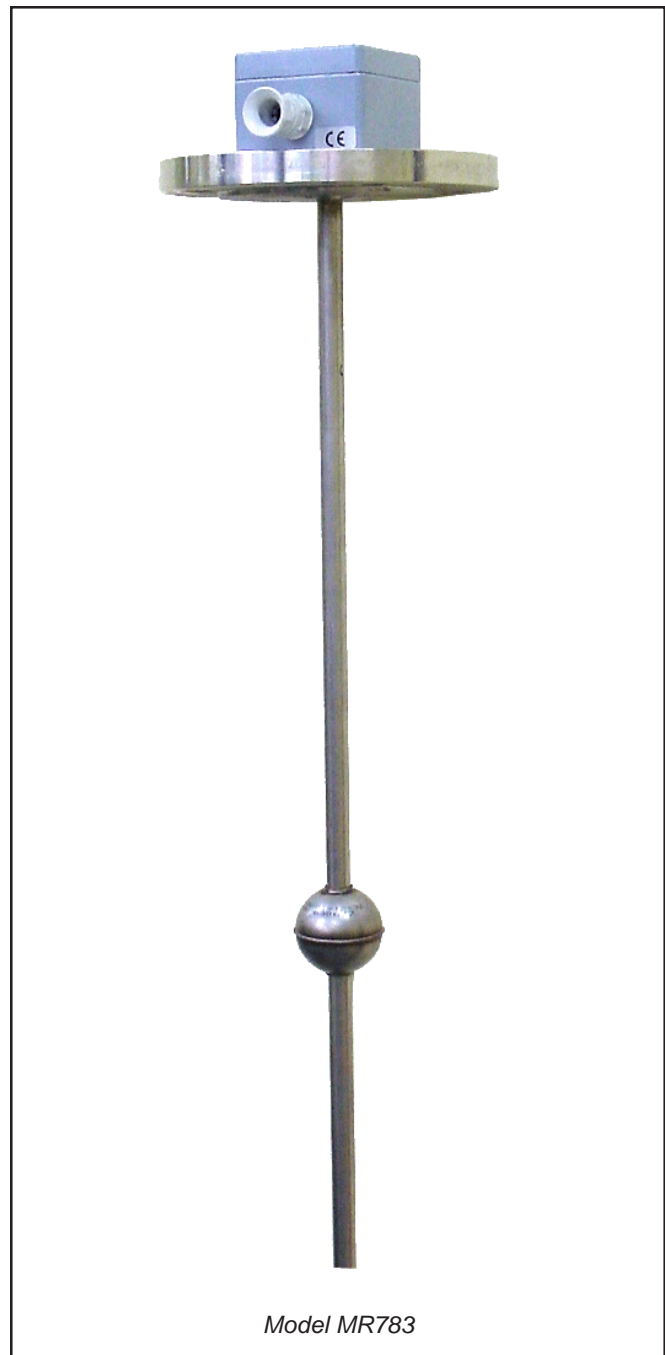

Magnetic Level Switches

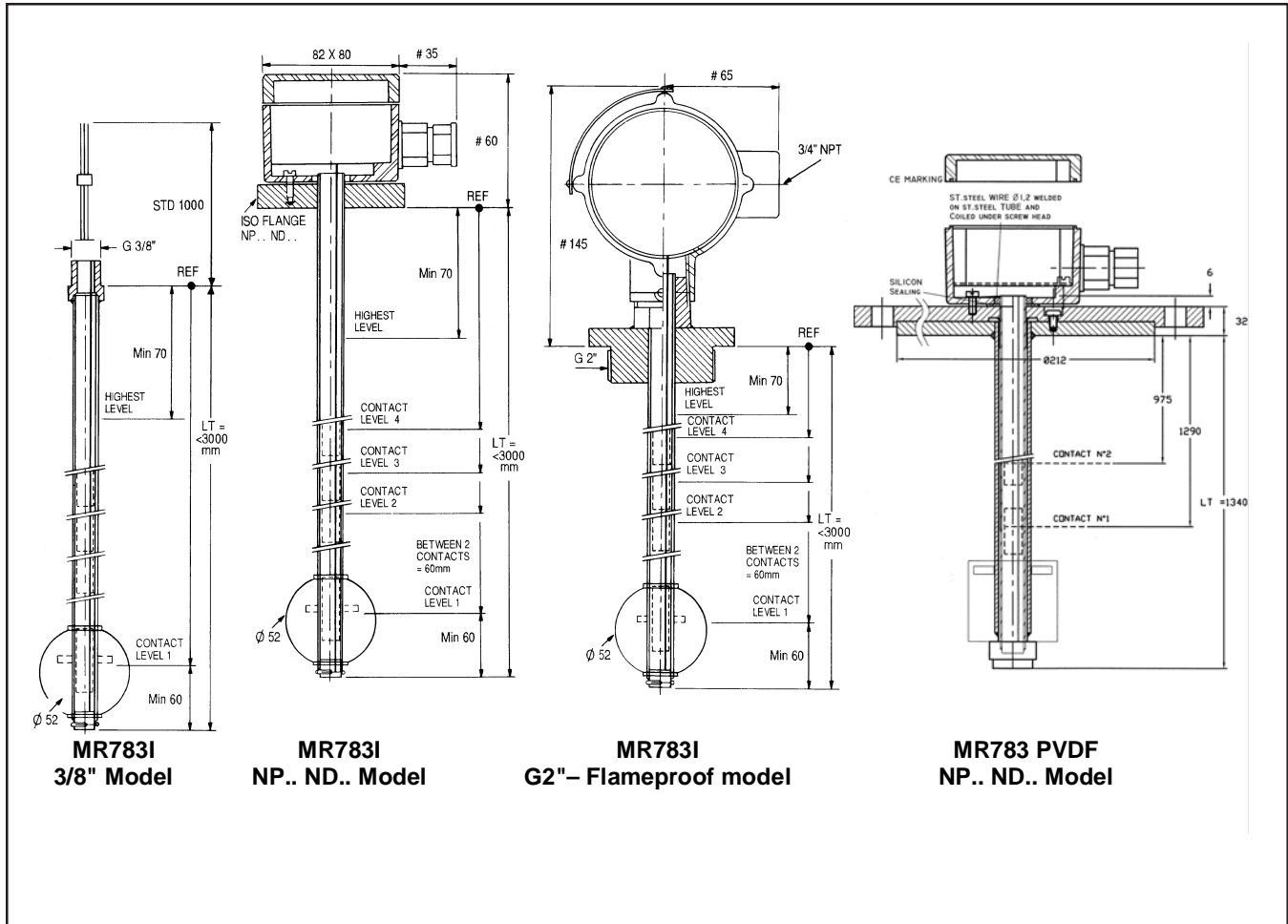

Model MR783 Dimensions

Type	MR 783 I (ST-Steel)	MR783 PVC	MR 783 PVDF
Min. Specific gravity	0.75	0.8	0.8
Max. temperature	100°C (212°F)	40°C (104°F)	70°C (158°F)
Max. Pressure	32 bar* (464 psi)	3 bar (44 psi)	3 bar (44 psi)

* For flanged instrument version, The nominal pressure of the flange should be in accordance with the operating pressure

For all inquiries or order placements, the following information is required:

Product Certifications and Specifications

Connections:

- Threaded plug 2" BSPP or 2" NPT or on request (see code for ordering)
- Flange PN. . DN . . according to 29203 standard
- 3/8" gas connecting
- Others on request

Detection boxes type :

Aluminium alloy standard type

Code : **H3**

- Aluminium box (82mm x 80mm)
- Housing protection : IP 65
- Cable gland : Polycarbonate material, fitted with retaining ring and shearing shield (wiring from 8 mm to 10mm)
- Other in option
- Electrical connection on screw electrical terminals (suitable for 1,5mm² electrical wires)

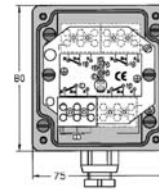

Aluminium alloy Flame-proof version (ATEX - IECEx approved)

Code : **H2**

- Detection box made of light aluminium alloy
- ATEX / Flame-proof certified : LCIE01ATEX 6060X IECEx LCI 09.0017X
- Marking : **CE 0081 Ex II 2 G EExd II C T6**
- Cable gland: EExd made of niched brass, suitable for armoured cables from 5mm to 12mm diameter size.
- Electrical connection on screw electrical terminals (suitable for 1,5mm² electrical wires)

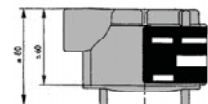
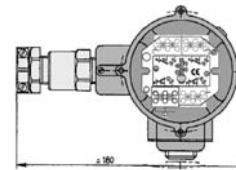

Stainless steel Flame-proof version (ATEX - IECEx approved)

Code : **H5**

- Detection box made of 316L stainless steel.
- ATEX / Flame-proof certified : LCIE01ATEX 6060X IECEx LCI 09.0017X
- Marking : **CE 0081 Ex II 2 G EExd II C T6**
- Cable entry M20 x 1.5
- Cable gland on request.
- Electrical connection on screw electrical terminals (suitable for 1,5mm² electrical wires)

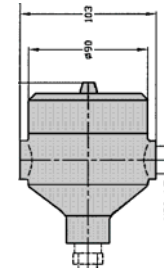

Aluminium alloy standard type (ATEX - IECEx approved)

Code : **H4**

- Aluminium box; Housing protection : IP 65
- ATEX / Flame-proof certified : LCIE01ATEX 6034X IECEx LCI 09.0017X
- Marking : **CE 0081 Ex II 2 G Exia II C T6-T4**
- Cable gland: EExe Pg11 made of blue polyamide (d=6 to 10 mm)
- Electrical settings :
 Ui ≤ 30V ; Ii = 50mA ; Pi = 0,4W ;
 Ci = OnF ; Li=0mH

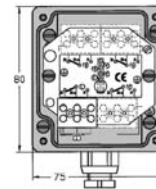

Stainless steel Flame-proof version (ATEX - IECEx approved)

Code : **H6**

- Detection box made of 316L stainless steel.
- ATEX / Flame-proof certified : LCIE01ATEX 6034X IECEx LCI 09.0017X
- Marking : **CE 0081 Ex II 2 G Exia II C T6-T5-T4**
- Cable entry M20 x 1.5
- Cable gland on request.
- Electrical connection on screw electrical terminals (suitable for 1,5mm²

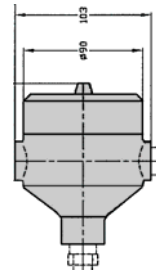

Contacts

Switches

- ILS / change over reed switches types
- Max. current : 1 A
- Max. voltage: 250V DC or AC
- Max. power : 60VA/ 30W (resistive charge)
- Quantity: MR783 : 1up to 4

Magnetic Level Switches

MR783 Model Code

CODE	INSTRUMENT TYPE - MATERIAL	
MR783 I	Stainless steel 316L + float 316 Ti	
MR783 PVC	Wetted parts material : PVC	
MR783 PVDF	Wetted parts material: PVDF	

CODE	DIMENSION OF CONNECTIONS	
3/8"	BSPP thread – stainless steel	
2"	BSPP thread – stainless steel	
2 1/2"	BSPP thread – PVC - PVDF	
65	ISO PN16 DN65 – Stainless steel , PVC, PVDF	
80	ISO PN16 DN80 – Stainless steel , PVC, PVDF	
100	ISO PN16 DN100 – Stainless steel , PVC, PVDF	
125	ISO PN16 DN125 – PVDF	
150	ISO PN16 DN150 – PVDF	
2 1/2"	ANSI B.16-5 DN 2 1/2" flange - Stainless steel ; PVC, PVDF	
3"	ANSI B.16-5 DN 3" flange – Stainless steel , PVC, PVDF	
4"	ANSI B.16-5 DN 4" flange – Stainless steel , PVC, PVDF	
5"	ANSI B.16-5 DN 5" flange – PVDF	
6"	ANSI B.16-5 DN 6" flange – PVDF	

CODE	FLOAT TYPE	
M1	Stainless steel 316L	0.75 < d < 1.6 p < 30b T < 100°C
	PVC	0.8 < d < 1,6 p < 3b T < 40°C
	PVDF	0,8 < d < 1,6 p < 3b T < 100°C
MX	Special float On request	

CODE	CONNECTION TYPE	
C1	Threaded	BSPP
C2	Flange	ISO NP 16 DN...
C3	Flange	ANSI 150# PN20 DN...
CX	Special design on request	

CODE	HOUSING TYD	
H0	Without housing (wiring length 1mm – 1 contac	
H2	EExd IIC T6 Aluminium Housing	
H3	Standard IP65 aluminium housing	
H4	EExia Standard IP65 aluminium housing	
H5	EExid IIC T6 stainless steel housing	
H6	EExia IIC T6 stainless steel housing	

CODE	CONTACT QUANTITY	
S1	1 reed switch contact SPDT	
S2	2 reed switch contacts SPDT	
S3	3 reed switch contacts SPDT	
S4	4 reed switch contact SPDT	

CODE	OPTIONS	
Z1	ATEX Flame- proof Cable gland for type H2	
Z2	1 float per each contact	
Z3	extra cable length for housing type H0	
Z9	Epoxy paint for housing	
Z11	ADE4FNickel brass– 3/4" NPT Cable Gland 8.5/16	

MR783I	3"	M1	C2	H1	S4	Z9
---------------	-----------	-----------	-----------	-----------	-----------	-----------

Due to Brooks Instrument's commitment to continuous improvement of our products, all specifications are subject to change without notice.

TRADEMARKS

Brooks Brooks Instrument, LLC



Brooks Instrument
407 West Vines Street
P.O. Box 903
Hatfield, PA 19440-0903 USA
T (215) 362-3700
F (215) 362-3745
E-Mail BrooksAm@BrooksInstrument.com
www.BrooksInstrument.com

Brooks Instrument
Neonstraat
6718 WX Ede, Netherlands
T +31 318 549 300
F+ 31 318 549 309
E-Mail BrooksEu@BrooksInstrument.com

Brooks Instrument
1-4-4 Kitasuna Koto-Ku
Tokyo, 136-0073 Japan
T +81 (0) 3 5633 7100
F +81 (0) 3 5633 7101
E-Mail BrooksAs@BrooksInstrument.com

Brooks Instrument S.A.S.
Z.A.de la Tour - ABREST -France
T +33 (0)4 70 59 81 81
F +33 (0)4 70 59 96 37
www.BrooksInstrument.com