

O-ring Seal Flowmeter Model 1305

FEATURES AND BENEFITS

- Capacity ranges 0.8 to 50 gpm; 3 to 50 scfm
- O-ring seal construction
- Sturdy bolted side-plate construction
- Standard NPT connections
- Vertical inlets and outlets standard, horizontal outlet with alarm
- Alarm switch adjustable for high or low flow indication

DESCRIPTION

The Brooks® Model 1305 glass tube flowmeters provide a low cost means of flow rate indication and alarm signaling. They are designed for applications where the metering accuracy requirements are not severe. These meters are ideal for purge type service, seal oil systems, bearing lubrication and cooling water indication. Model 1305 is available with vertical inlets and outlets and standard materials of construction only. A general purpose alarm, with flow contacts over the entire flow range, is optional.

SPECIFICATIONS

Capacities and Pressure Drops

Refer to Table 1

Accuracy

Standard Flow Accuracy: $\pm 10\%$ Full Scale from 100% to 10% of scale reading

Optional Flow Accuracy: $\pm 5\%$ Full Scale from 100% to 10% of scale reading

Repeatability

1% Full Scale

Pressure Ratings

Meter	Maximum Working Pressure (psig) at 250°F (121°C) for gases
8	200
10	150
12	75

Note: Hydrostatic test pressure is 1.5 times the working pressure



Model 1305

Scales

Length: Size 8 and 10— 75 mm (3")
Size 12 — 127 mm (5")

Graduations:

Standard: On-tube printed scale (Millimeter scale with approximate calibration curve, direct reading gpm water or scfm air) OR Detachable printed scale (Choice of direct reading units, millimeter or percentage of maximum flow with factor tag.)

Ambient Temperature Limits

33°F to 125°F (1°C to 52°C)

Operating Fluid Temperature Limits

Maximum: 250°F (121°C) for gas service

Minimum: 33°F (1°C)

Connections

Standard: Female NPT

Connection Orientation

Standard: Vertical inlets and outlets

With Alarm: Horizontal outlets

Meter Dimensions

Refer to Figure 1

Brooks® Model 1305

ORDERING INFORMATION AND MODEL CODE

Refer to Table 2

Material of Construction:

Metering Tube

Borosilicate Glass

Protective Tube Sleeve

UV stabilized polycarbonate

Window

Scratch resistant, UV stabilized polycarbonate

Floats & Float Stops

316 stainless steel

Housing

Aluminum side plates

End Fittings

Brass, 316 stainless steel

O-rings

Buna-N, Viton-A®

Bolts

300 series stainless steel

OPTIONAL EQUIPMENT

Alarm Limit Switches

Integral, single or dual reed switch alarms available for Sizes 8 and 10 meters. Up to two alarm switches can be installed to provide initiation of signal at pre-set flow values. Settings can be adjusted by loosening and retightening the alarm switches.

Alarm Specifications:

Ambient Temperature Limits

33°F to 125°F (1°C to 52°C)

Operating Fluid Temperature Limits

Maximum: 250°F (121°C) for gas service

Minimum: 33°F (1°C) for gas and liquid service

Alarm Dimensions and Wiring Diagrams

Dimensions: Refer to Figure 2

Wiring Diagrams: Refer to Figures 3 and 4

Alarm Accessories

Single or double-pole, double-throw (SPDT or DPDT) relays units are offered in 110 Volts.

Table 1 Capacities

METER SIZE	TUBE	WATER			AIR @ STP		
		FLOAT	GPM	PRESSURE DROP INCHES W.C.	FLOAT	SCFM	PRESSURE DROP INCHES W.C.
8	R-8M-75-1	8-RV-8	0.80	8.0	8-RV-8	3.00	9.0
		8-RJ-10	1.50	9.0	8-RJ-10	6.00	11.0
		8-RJ-23	2.50	13.0	8-RJ-23	10.00	15.0
		8-RJ-30	3.50	19.0	8-RJ-30	14.00	22.0
		8-RJ-39	5.00	34.0			
	R-8M-75-A W/6200 ALARM	8-RVA-28	2.50	15.0	8-RVA-20	6.00	15.0
		8-RSA-53	5.00	43.0	8-RVA-28	12.00	43.0
10	R-10M-75-3	10-RJ-80	10.00	18.0	10-RJ-37	24.00	18.0
		10-RJ-120	15.00	35.0	10-RJ-83	35.00	35.0
		10-RJ-180	25.00	71.0	10-RJ-90	50.00	71.0
	R-10M-75-3 W/6200 ALARM	10-RJA-67	10.00	18.0	10-RJA-50	24.00	18.0
		10-RJA-100	15.00	35.0	10-RJA-54	35.00	35.0
		10-RJA-156	25.00	71.0	10-RJA-64	50.00	71.0
12	R-12M-127-3F	35 GPM	35.00	27.0			
		50 GPM	50.00	73.0			

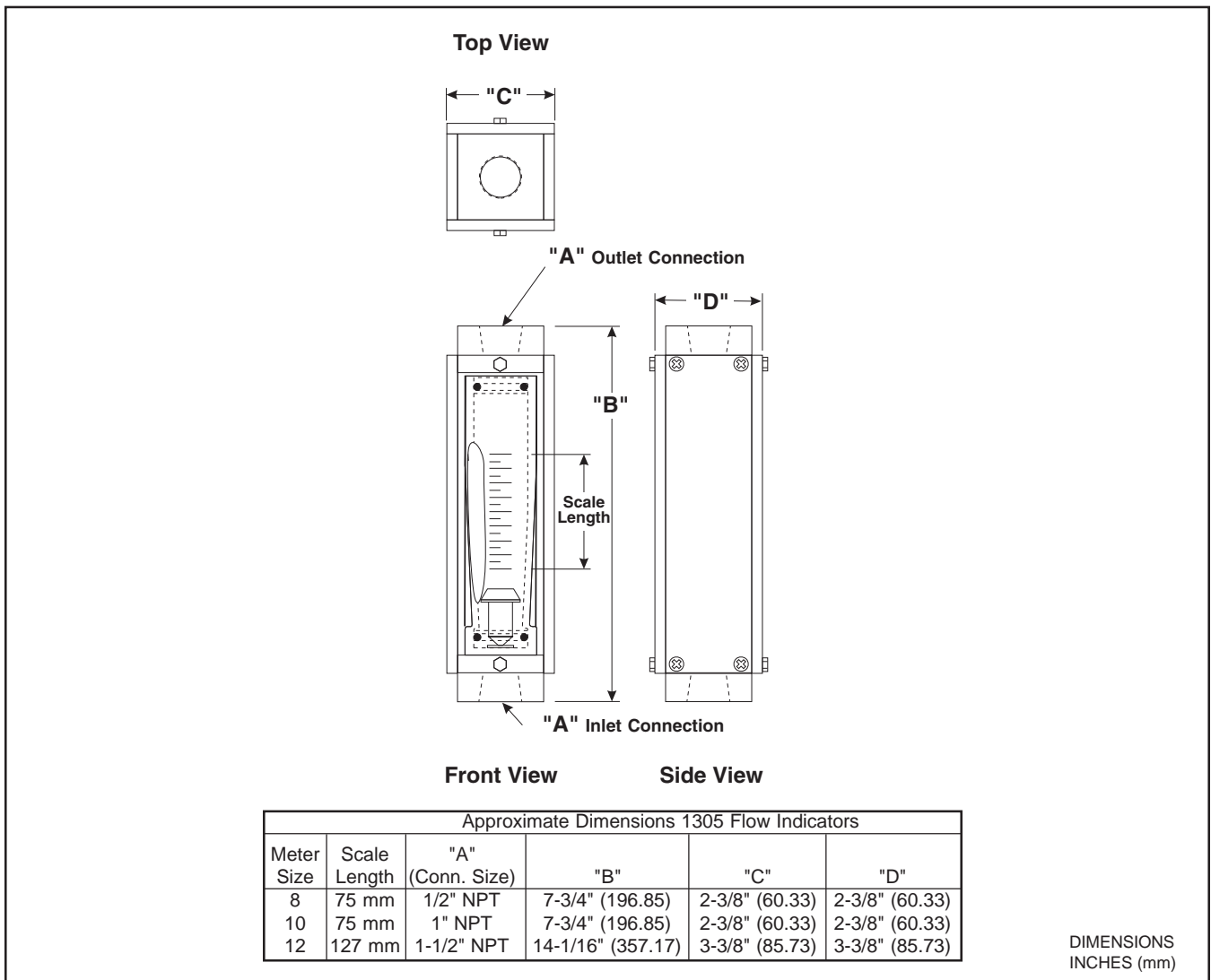
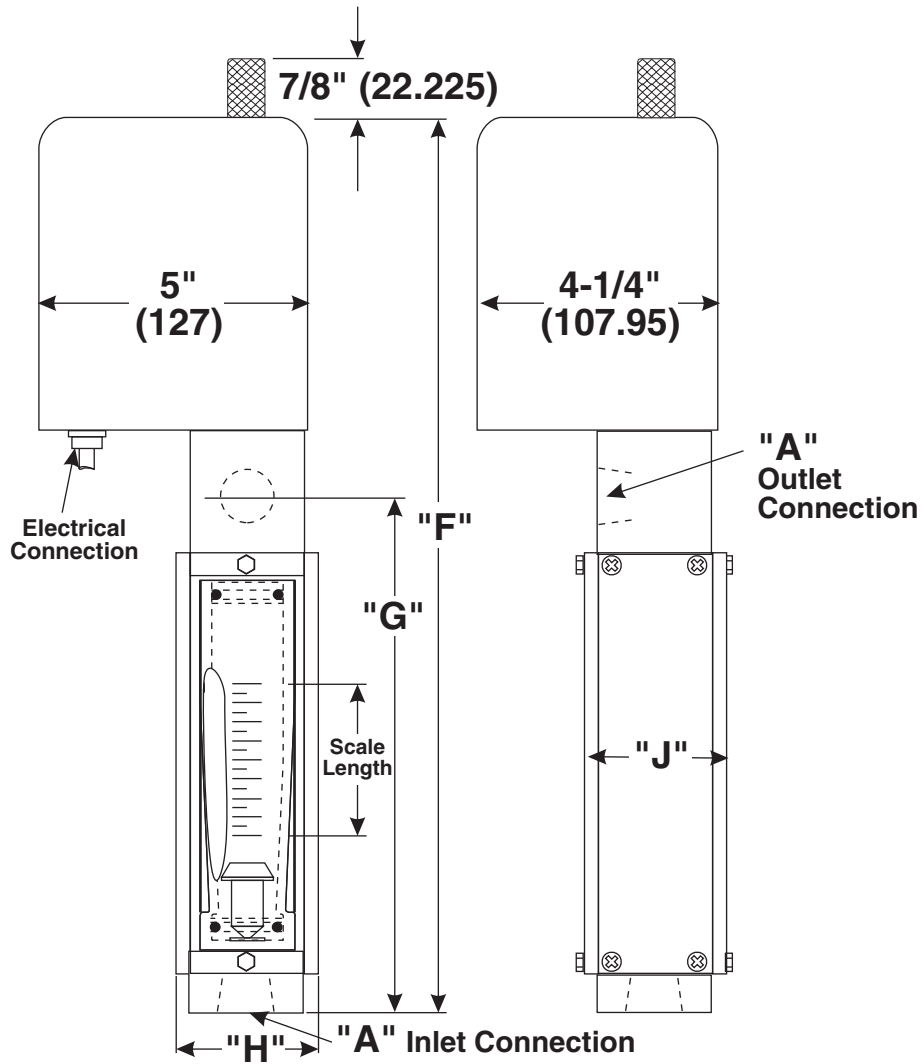

Figure 1 Model 1305 Dimensions

Brooks® Model 1305



Front View Side View
DOUBLE CASE ALARM

Approximate Dimensions 1305 Flow Alarms							
Meter Size	Scale Length	"A" (Conn. Size)	"E"	"F"	"G"	"H"	"J"
8	75 mm	1/2" NPT	13"(330.2)	14"(355.6)	8-1/8"(206.38)	2-3/8"(60.33)	2-3/8"(60.33)
10	75 mm	1" NPT	13"(330.2)	14"(355.6)	8-1/8"(206.38)	2-3/8"(60.33)	2-3/8"(60.33)

DIMENSIONS
 INCHES (mm)

Figure 2 Model 1305, Sizes 8 and 10 with Model 6221 (SPDT) or Model 6222 (DPDT) Alarms

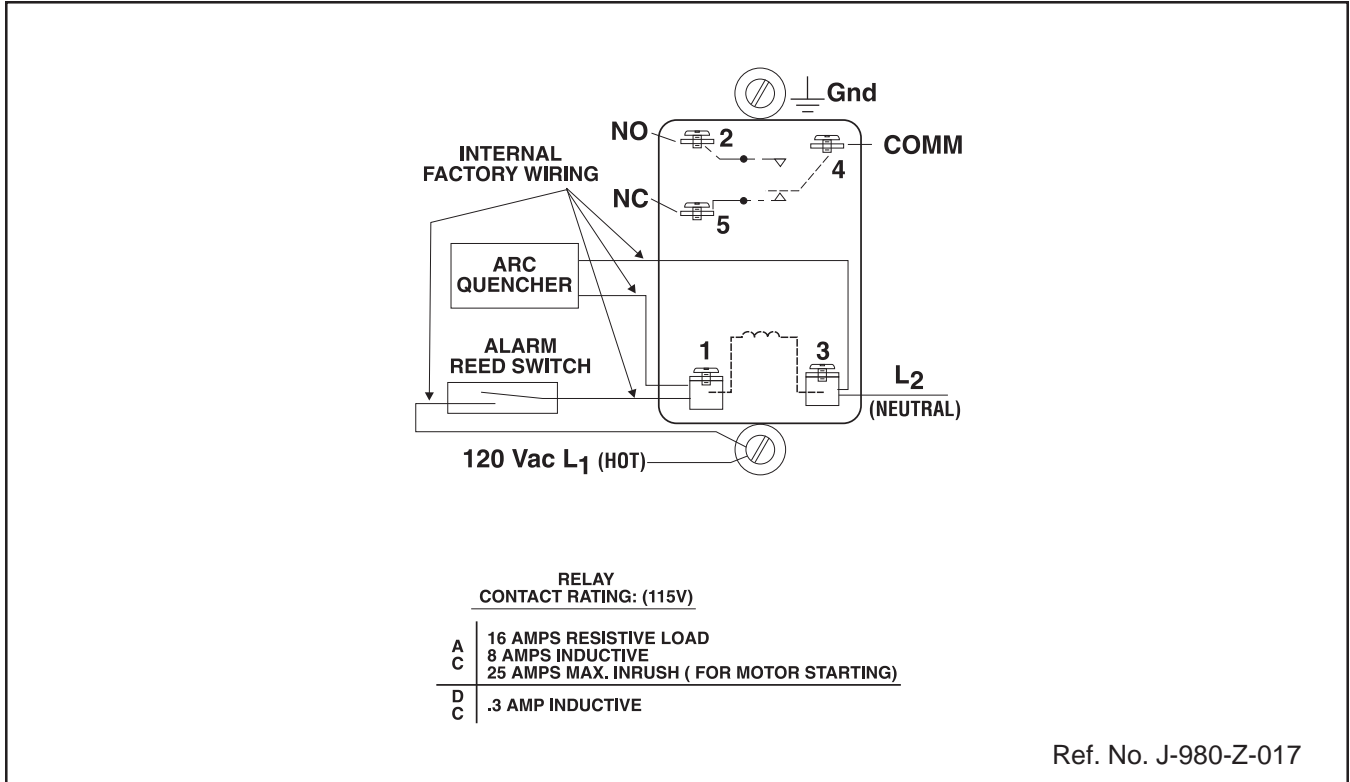

Figure 3 Alarm Wiring Diagram, Model 6221 (SPDT) Relay

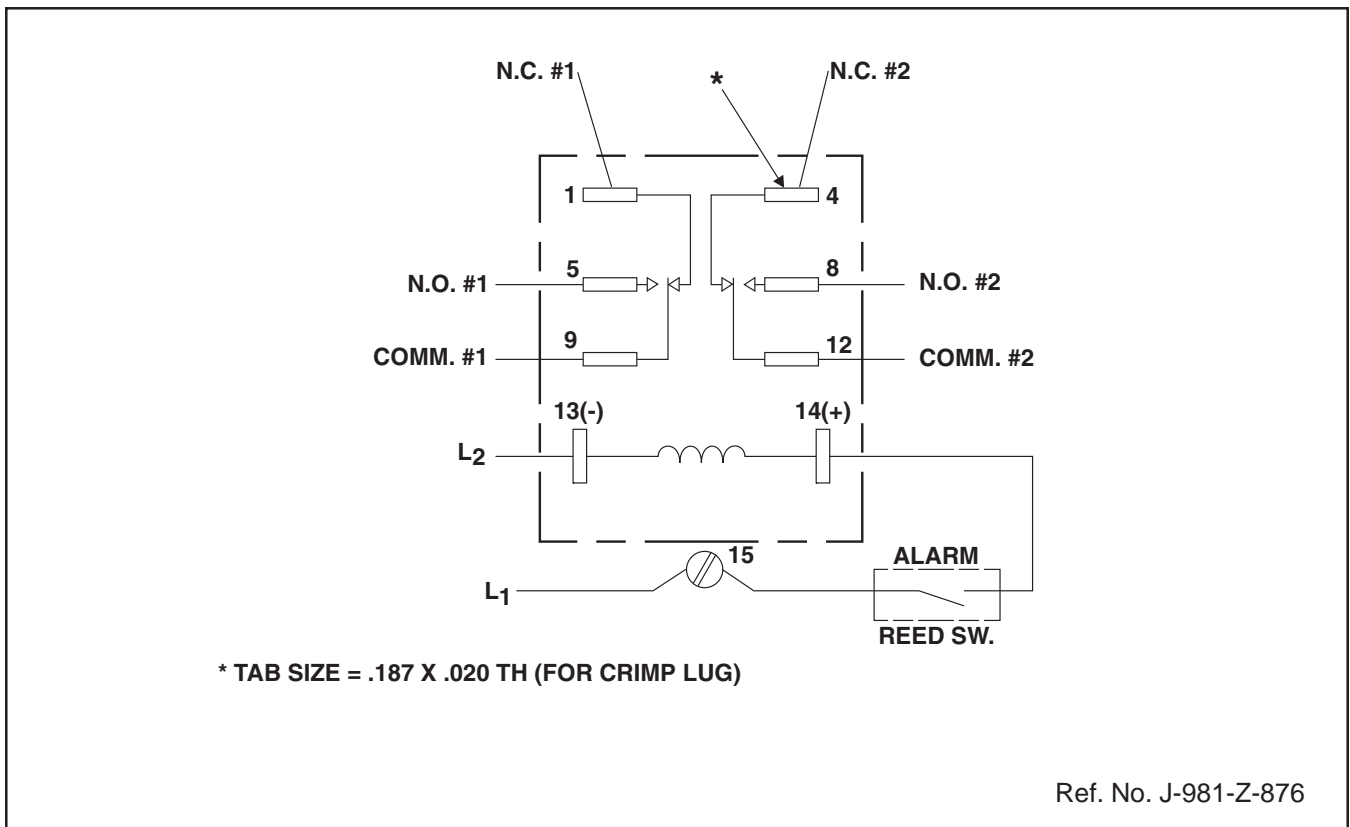

Figure 4 Alarm Wiring Diagram, Model 6222 (DPDT) Relay

Brooks® Model 1305

Table 2 Ordering Information and Model Code

MODEL	VARIABLE AREA FLOWMETER			
1305F	THREADED			
CODE	TUBE DESIGNATOR			
J1	R-8M-75-1			
L1	R-10M-75-3			
M1	R-12M-127-3F			
	FLOAT DESIGNATOR			
CODE	SIZE 8	SIZE 10	SIZE 12	
2C	8-RV-8			
5C		10-RJ-37		
6C		10-RJ-80	35 GPM	
7C		10-RJ-83	50 GPM	
8C	8-RJ-10	10-RJ-90		
9C	8-RJ-23	10-RJ-120		
AC	8-RJ-30	10-RJ-180		
BC	8-RJ-39	10-RJA-50		
CC	8-RVA-20			
DC		10-RJA-54		
EC	8-RVA-28			
FC		10-RJA-64		
GC	8-RSA-53			
HC		10-RJA-67		
KC		10-RJA-100		
MC		10-RJA-156		
	CODE	SCALE (NOTE 1)		
	A1	NO INSCRIPTION (BLANK)		
	B1	MM SCALE-DETACHABLE		
	B2	MM SCALE-ON TUBE		
	C1	0-100 LINEAR-DETACHABLE		
	C2	0-100 LINEAR-ON TUBE		
	H1	LPM AIR @STP DETACHABLE		
	J1	GPM WATER SP. GR. 1.0, VISC 1.0 CP DETACHABLE		
	J2	GPM WATER SP. GR. 1.0, VISC 1.0 CP ON TUBE		
	K1	LPM WATER SP. GR. 1.0, VISC 1.0 CP DETACHABLE		
	L1	SCFM AIR @STP DETACHABLE		
	L2	SCFM AIR @STP ON TUBE		
		THE FOLLOWING SELECTIONS ARE DETACHABLE		
	M1	SPECIAL INSCRIPTION (SPECIAL CALIBRATION NOT REQ'D)		
	N1	SPECIAL CALIBRATION WITH SCALE 10% FS GAS		(NOTE 2)
	N3	SPECIAL CALIBRATION WITH SCALE 10% FS LIQUID		(NOTE 2)
	N5	SPECIAL CALIBRATION WITH SCALE 10% FS VISCOSITY		
	P1	SPECIAL CALIBRATION WITH SCALE 5% FS GAS		
	P3	SPECIAL CALIBRATION WITH SCALE 5% FS LIQUID		
	P5	SPECIAL CALIBRATION WITH SCALE 5% FS VISCOSITY		

1305F J1 9C C2 A A TYPICAL MODEL CODE

- NOTES**
- SELECTIONS B2, C2, J2, L2 ARE STANDARD SIZE 8 & 10
SELECTIONS B1, C1, J1, L1 ARE STANDARD ON SIZE 12
 - SPECIFY ONLY IF NIST CERTIFICATION IS REQUIRED
 - SELECTION N2, N4, N6, P2, P4, AND P6 ONLY AVAIL. W/ MM SCALE
SCALE ON TUBE. NOT AVAILABLE ON SIZE 12 METER

Table 2 Ordering Information and Model Code (Continued)

CODE	MATERIALS OF CONSTRUCTION (NOTE 4)				ADD
	FITTING	O-RING	SIDE PLATES		
A	BRASS	BUNA	ALUMINUM	NOT SIZE 12	TABLE A
B	316 S.S.	VITON	ALUMINUM		TABLE A
C	316 S.S.	VITON	STN. STL.		TABLE A
D	316 S.S.	BUNA	ALUMINUM		TABLE A
E	BRASS	VITON	ALUMINUM	NOT SIZE 12	TABLE A
	CODE	ACCESSORIES (SELECT UP TO 3)			ADD
	A	NONE			NC
	B	EXTENSION MOUNTED ALARM GENERAL PURPOSE (NOTE 5,6)			TABLE C

1305F J1 9C C2 A A TYPICAL MODEL CODE

EXTENSION ALARM ADDER (NOTE 6)

MODEL	EXTENSION ALARM			BASE
6221-	GENERAL PURPOSE SIZES 8 AND 10	1 SWITCH	1 RELAY	TABLE C
6222-	GENERAL PURPOSE SIZES 8 AND 10	2 SWITCH	2 RELAY	TABLE C
	CODE	METER SIZE		ADD
	08	SIZE 8		TABLE C
	10	SIZE 10		TABLE C
	CODE	METER ADAPTED TO		ADD
	C0A0	GENERAL PURPOSE ALARM (Model 6221 & 6222)		NC
	CODE	ACCESSORIES (NOTE 5)		ADD
	A	NONE		NC

6221- 8 C0A0 A TYPICAL MODEL CODE

- NOTES 4 VITON IS STD. W/ 316 S.S. FITTING, BUNA IS STD. W/ BRASS FITTING
 5 ACCESSORY MUST BE SPECIFIED AS SEPARATE LINE ITEM
 6 METERS WITH ALARM HAVE HORIZONTAL OUTLET CONNECTION

Approximate Shipping Weight (lbs.)

MODEL	SIZE		
	8	10	12
1305	7	5	8
1305-6221	17	17	N/A
1305-6222	17	17	N/A

Brooks® Model 1305

BROOKS SERVICE AND SUPPORT

Brooks is committed to assuring all of our customers receive the ideal flow solution for their application, along with outstanding service and support to back it up. We operate first class repair facilities located around the world to provide rapid response and support. Each location utilizes primary standard calibration equipment to ensure accuracy and reliability for repairs and recalibration. The primary standard calibration equipment to calibrate our flow products is certified by our local Weights and Measures Authorities and traceable to the relevant International Standards.

Visit www.BrooksInstrument.com to locate the service location nearest to you.

START-UP SERVICE AND IN-SITU CALIBRATION



Brooks Instrument can provide start-up service prior to operation when required. For some process applications, where ISO-9001 Quality Certification is important, it is mandatory to verify and/or (re)calibrate the products periodically. In many cases this service can be provided under in-situ conditions, and the results will be traceable to the relevant international quality standards.

CUSTOMER SEMINARS AND TRAINING

Brooks Instrument can provide customer seminars and dedicated training to engineers, end users and maintenance persons. Please contact your nearest sales representative for more details.

HELP DESK

In case you need technical assistance:

Americas		1 888 554 FLOW
Europe		+31 (0) 318 549 290
Asia		+81 (0) 3 5633 7100

Due to Brooks Instrument's commitment to continuous improvement of our products, all specifications are subject to change without notice.

TRADEMARKS

Brooks Brooks Instrument, LLC
Viton-A DuPont Performance Elastomers



Brooks Instrument
407 West Vine Street
P.O. Box 903
Hatfield, PA 19440-0903 USA
T (215) 362 3700
F (215) 362 3745
E-Mail BrooksAm@BrooksInstrument.com
www.BrooksInstrument.com

Brooks Instrument
Neonstraat
6718 WX Ede, Netherlands
T +31 (0) 318 549 300
F +31 (0) 318 549 309
E-Mail BrooksEu@BrooksInstrument.com

Brooks Instrument
1-4-4 Kitasuna Koto-Ku
Tokyo, 136-0073 Japan
T +81 (0) 3 5633 7100
F +81 (0) 3 5633 7101
E-Mail BrooksAs@BrooksInstrument.com